

ON GRAPHS WHOSE MAXIMAL CLIQUES
AND STABLE SETS INTERSECT

Diogo V. Andrade^a Endre Boros^b
Vladimir Gurvich^c

RRR 17-2006, JULY 2006

RUTCOR
Rutgers Center for
Operations Research
Rutgers University
640 Bartholomew Road
Piscataway, New Jersey
08854-8003
Telephone: 732-445-3804
Telefax: 732-445-5472
Email: rrr@rutcor.rutgers.edu
<http://rutcor.rutgers.edu/~rrr>

^aRUTCOR, Rutgers University, 640 Bartholomew Road, Piscataway NJ
08854-8003; email: dandrade@rutcor.rutgers.edu

^bRUTCOR, Rutgers University, 640 Bartholomew Road, Piscataway NJ
08854-8003; email: boros@rutcor.rutgers.edu

^cRUTCOR, Rutgers University, 640 Bartholomew Road, Piscataway NJ
08854-8003; email: gurvich@rutcor.rutgers.edu

The author is grateful to DIMACS, the NSF Center for Discrete Mathematics
and Theoretical Computer Science, for partial support

RUTCOR RESEARCH REPORT

RRR 17-2006, JULY 2006

ON GRAPHS WHOSE MAXIMAL CLIQUES AND
STABLE SETS INTERSECT

Diogo V. Andrade

Endre Boros

Vladimir Gurvich

Abstract. We say that a graph G has the CIS-property and call it a CIS-graph if every maximal clique and every maximal stable set of G intersect.

By definition, G is a CIS-graph if and only if the complementary graph \overline{G} is a CIS-graph. Let us substitute a vertex v of a graph G' by a graph G'' and denote the obtained graph by G . It is also easy to see that G is a CIS-graph if and only if both G' and G'' are CIS-graphs. In other words, CIS-graphs respect complementation and substitution. Yet, this class is not hereditary, that is, an induced subgraph of a CIS-graph may have no CIS-property. Perhaps, for this reason, the problems of efficient characterization and recognition of CIS-graphs are difficult and remain open. In this paper we only give some necessary and some sufficient conditions for the CIS-property to hold.

There are obvious sufficient conditions. It is known that P_4 -free graphs have the CIS-property and it is easy to see that G is a CIS-graph whenever each maximal clique of G has a simplicial vertex. However, these conditions are not necessary. There are also obvious necessary conditions. Given an integer $k \geq 2$, a *comb* (or *k-comb*) S_k is a graph with $2k$ vertices k of which, v_1, \dots, v_k , form a clique C , while others, v'_1, \dots, v'_k , form a stable set S , and (v_i, v'_i) is an edge for all $i = 1, \dots, k$, and there are no other edges. The complementary graph $\overline{S_k}$ is called an *anti-comb* (or *k-anti-comb*). Clearly, S and C switch in the complementary graphs. Obviously, the combs and anti-combs are not CIS-graphs, since $C \cap S = \emptyset$. Hence, if a CIS-graph G contains an induced comb or anti-comb then it must be settled, that is, G must contain a vertex v connected to all vertices of C and to no vertex of S . However, these conditions are only necessary.

The following sufficient conditions are more difficult to prove: G is a CIS-graph whenever G contains no induced 3-combs and 3-anti-combs, and every induced 2-comb is settled in G . It is an open question whether G is a CIS-graph if G contains no induced 4-combs and 4-anti-combs, and all induced 3-combs, 3-anti-combs, and 2-combs are settled in G .

We generalize the concept of CIS-graphs as follows. For an integer $d \geq 2$ we define a *d-graph* $\mathcal{G} = (V; E_1, \dots, E_d)$ as a complete graph whose edges are colored by d colors (that is, partitioned into d sets). We say that \mathcal{G} is a CIS- d -graph (has the CIS- d -property) if $\bigcap_{i=1}^d C_i \neq \emptyset$ whenever for each $i = 1, \dots, d$ the set C_i is a maximal color i -free subset of V , that is, $(v, v') \notin E_i$ for any $v, v' \in C_i$. Clearly, in case $d = 2$ we return to the concept of CIS-graphs. (More accurately, CIS-2-graph is a pair of two complementary CIS-graphs.) We conjecture that each CIS- d -graph is a Gallai graph, that is, it contains no triangle colored by 3 distinct colors. We obtain results supporting this conjecture and also show that if it holds then characterization and recognition of CIS- d -graphs are easily reduced to characterization and recognition of CIS-graphs.

We also prove the following statement. Let $\mathcal{G} = (V; E_1, \dots, E_d)$ be a Gallai d -graph such that at least $d - 1$ of its d chromatic components are CIS-graphs, then \mathcal{G} has the CIS- d -property. In particular, the remaining chromatic component of \mathcal{G} is a CIS-graph too. Moreover, all 2^d unions of d chromatic components of \mathcal{G} are CIS-graphs.

Key words: CIS-graphs, CIS-property, clique, clique-kernel intersection property, graph, independent set, simplicial vertex, stable graph, stable set, substitution.

1 Introduction.

1.1 CIS-graphs and simplicial vertices

Given a graph G , we say that it has the *CIS-property*, or equivalently that G is a *CIS-graph*, if every maximal clique C and every maximal stable set S in G intersect. Obviously, they may have at most one common vertex and hence $|C \cap S| = 1$. It is convenient to represent a CIS-graph G as a *2-dimensional box partition*, that is, a matrix whose rows and columns are labeled respectively by the maximal cliques and stable sets of G and whose entries are the (unique) vertices of the corresponding intersections. For example, Figure 1 shows four CIS-graphs and their intersection matrices. More examples are given in Figures 6, 7 and 10.

The CIS-property appears in the survey [6] (under the name *clique-kernel intersection property*) but no related results are mentioned. Indeed, natural problems of efficient characterization and recognition of the CIS-graphs look difficult and remain open. Perhaps, one of the reasons is that the CIS-property is not hereditary. Indeed, if $C \cap S = \{v\}$ then $C \setminus \{v\}$ and $S \setminus \{v\}$ may become disjoint maximal clique and stable set after v is deleted.

On the positive side, by definition, the CIS-property is self-complementary, that is, G is a CIS-graph if and only if the complementary graph \overline{G} is a CIS-graph.

We start with a simple sufficient condition. Given a graph $G = (V, E)$, a vertex $v \in V$ is called *simplicial* if its neighborhood $N[v]$ is a clique.

Clearly, if a maximal clique C of G contains a simplicial vertex v then it is a *private* vertex of C , that is, v cannot belong to any other maximal clique, except C . Vice versa, every private vertex v of a maximal clique C is simplicial, since in this case $N[v] = C$.

Moreover, in this case $C \cap S \neq \emptyset$ for every maximal stable set S in G . Indeed, if $S \cap (C \setminus \{v\}) = \emptyset$ then $v \in S$, since S is maximal. Thus, we obtain the following statement.

Proposition 1. *Graph G is a CIS-graph whenever*

- (s) *every maximal clique of G has a simplicial vertex.* □

Let us remark that condition (s): is only sufficient but not necessary. For example, (s) holds for the first graph in Figure 1 but not for the other three graphs. Let us also remark that (s) does not hold for both graphs in Figure 2. Furthermore, (s) holds for the graphs of Figures 6, 7, and 10 and (s) does not hold for the graphs of Figures 4, 5, and 9, because they are not CIS-graphs.

By Proposition 1, given an arbitrary graph G , we can get a CIS-graph G^s just adding a simplicial (private) vertex v_C to each maximal clique C of G that does not have one.

Let us remark that we have to add such a vertex to C even when $C \cap S \neq \emptyset$ for each maximal stable set S in G , since otherwise C may become disjoint from a new maximal stable set of G^s ; consider, for example, $G = \overline{C_6}$.

Obviously, the size of G^s may be exponential in the size of G .

Corollary 1. *Any graph G is an induced subgraph of a CIS-graph.*

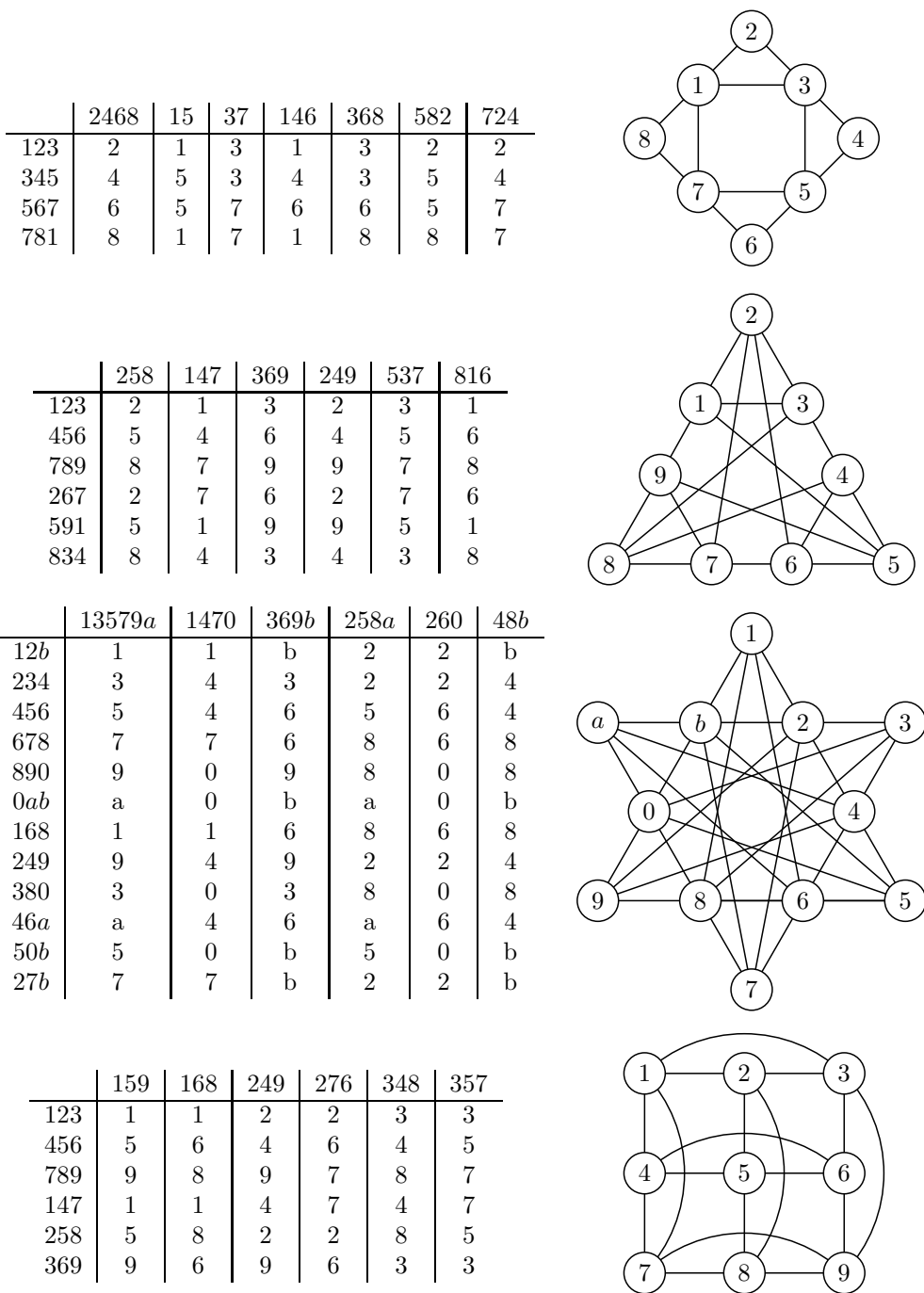

Figure 1: Four CIS-graphs and their intersection matrices.

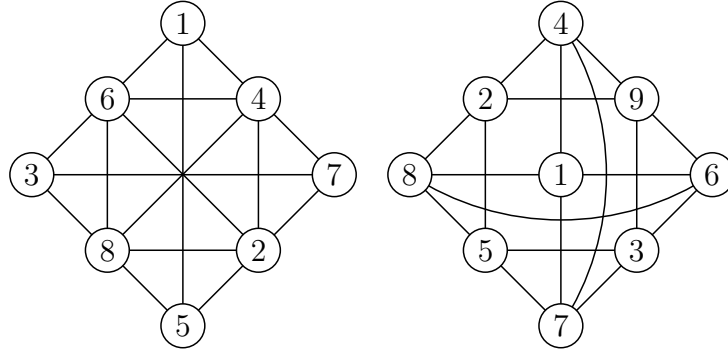

Figure 2: Complements to the first two graphs in the previous Figure. (Obviously, for every graph G the intersection matrix of \overline{G} is the transposed of the intersection matrix of G .)

Proof. Indeed, for any graph G the CIS-graph G^s contains G as an induced subgraph. \square

Thus, CIS-graphs cannot be characterized in terms of forbidden induced subgraphs. This is not surprising, since the CIS-property is not hereditary.

Remark 1. *Interestingly, this mapping $f : G \rightarrow G^s$ can be viewed as a “bridge” between perfect graphs and cooperative games [2]. Given a graph $G = (V, E)$, let $\mathcal{C} = \mathcal{C}_G$ and $\mathcal{S} = \mathcal{S}_G$ be, respectively, the families of all maximal cliques and stable sets of G . Let us assign a player (voter) i_C to each maximal clique $C \in \mathcal{C}_G$ and an outcome (candidate) a_S to each maximal stable set $S \in \mathcal{S}_G$. Furthermore, to every vertex $v \in V$ let us assign a coalition of players $K_v = \{i_C \mid v \in C\} \subseteq \mathcal{C}_G$ and block of outcomes $B_v = \{a_S \mid v \in S\} \subseteq \mathcal{S}_G$. Then let us introduce a family of coalitions $\mathcal{K}_G = \{K_v \mid v \in V\}$ and define an effectivity function $\mathcal{E}_G : 2^{\mathcal{C}} \times 2^{\mathcal{S}} \rightarrow \{0, 1\}$ by formula $\mathcal{E}_G(K, B) = 1$ iff $K_v \subseteq K$ and $B_v \subseteq B$ for some $v \in V$. It is proved in [2, 3, 4] that the following claims are equivalent:*

- (i) Graph G is perfect;
- (ii) Effectivity function \mathcal{E}_G is stable;
- (iii) Family of coalitions \mathcal{K}_G is stable.
- (iv) Family of coalitions \mathcal{K}_{G^s} is partitionable.

A family of sets is called partitionable if every its minimal balanced subfamily is a partition. A family of coalitions or an effectivity function is called stable if the corresponding core is not empty for any utility function. We refer to [2, 3, 4] for accurate definitions.

1.2 Almost CIS-graphs and split graphs

We will call a graph $G = (V, E)$ an *almost CIS-graph* if every (maximal) clique C and stable set S in G intersect, except for a unique pair (C_0, S_0) .

By definition, almost CIS-graphs are closed under complementation. However, unlike CIS-graphs, they are not closed under substitution.

Notice that, by definition, the families of CIS- and almost CIS-graphs are disjoint.

Let us recall that $G = (V, E)$ is a *split* graph if $V = C_0 \cup S_0$, where C_0 and S_0 are (maximal) clique and stable set, respectively. Foldes and Hammer [15] showed that split graphs are exactly $(C_4, \overline{C_4}, C_5)$ -free graphs.

It is not difficult to see that every split graph is either a CIS-graph or an almost CIS-graph. More precisely, the following claim holds.

Proposition 2. *Let $G = (V, E)$ be a split graph in which C_0 and S_0 are maximal and $V = C_0 \cup S_0$. If $C_0 \cap S_0 \neq \emptyset$ then G is a CIS-graph, otherwise, if $C_0 \cap S_0 = \emptyset$, then G is an almost CIS-graph in which (C_0, S_0) is the only disjoint pair.*

Proof. Obviously, for each maximal clique C and stable set S in G we have: $C_0 \cap S \neq \emptyset$ unless $S = S_0$ and $C \cap S_0 \neq \emptyset$ unless $C = C_0$. Let us assume that both intersections are non-empty (then, clearly, each of them consists of a single vertex) and denote $C_0 \cap S$ by v_S and $C \cap S_0$ by v_C . If $v_C = v_S$ then $C \cap S = \{v_S\} = \{v_C\}$. Otherwise, if $(v_C, v_S) \in E$ then $C \cap S = \{v_S\}$; if $(v_C, v_S) \notin E$ then $C \cap S = \{v_C\}$. In any case $C \cap S \neq \emptyset$.

Thus, if $C \cap S = \emptyset$ then $C = C_0, S = S_0$, and $C_0 \cap S_0 = \emptyset$. □

Conjecture 1. *Every almost CIS-graph is a split graph.*

By [15], it would be sufficient to show that almost CIS graphs are $(C_4, \overline{C_4}, C_5)$ -free.

It would be also sufficient to prove that if (C_0, S_0) is the unique disjoint pair of an almost CIS-graph $G = (V, E)$ then $V = C_0 \cup S_0$, that is, $V' = V \setminus (C_0 \cup S_0) = \emptyset$. However, we can only show that the corresponding induced subgraph $G[V']$ cannot be a split graph. In other words, G is not almost CIS-graph whenever $V = C_0 \cup S_0 \cup C \cup S$, where C and C_0 are cliques, S and S_0 are stable sets, C_0 and S_0 are maximal, and $C_0 \cap S_0 = \emptyset$. However, we cannot prove that $V' = \emptyset$.

Obviously, given a split graph G with a unique disjoint pair $C_0 \cap S_0 = \emptyset$, we can get a split CIS-graph G_0 by adding to G the new vertex v_0 which is connected to each vertex of C_0 and to no vertex of S_0 . In other words, v_0 is a simplicial vertex of $C \cup \{v_0\}$ in G_0 and of $\overline{S} \cup \{v_0\}$ in $\overline{G_0}$.

1.3 P_4 -free CIS-graphs

We proceed with the following simple observation: every P_4 -free graph is a CIS-graph; see e.g. [12, 13, 16, 18, 19, 21, 25, 37]. In fact, a stronger claim holds. We say that a set $T \subseteq V$ is a transversal of the hypergraphs $\mathcal{H} \subseteq 2^V$ if $T \cap H \neq \emptyset$ for all hyperedges $H \in \mathcal{H}$. The family of minimal transversals of \mathcal{H} is denoted by \mathcal{H}^d and is called the *dual* of \mathcal{H} . Given a graph $G = (V, E)$ we assign to it two hypergraphs, $\mathcal{C} = \mathcal{C}_G$ the collection of all maximal cliques of G , and $\mathcal{S} = \mathcal{S}_G$ the collections of all its maximal stable sets.

Proposition 3 ([18, 21, 25]). *A graph G has no induced P_4 if and only if the hypergraphs \mathcal{C} and \mathcal{S} of all maximal cliques and stable sets of G are dual hypergraphs.* □

Furthermore, P_4 -free graphs are closely related to *read-once* Boolean functions and 2-person positional games, see for definitions, e.g., [17, 20, 21, 25].

Remark 2. Read-once Boolean functions can be efficiently characterized, since their co-occurrence graphs are P_4 -free, [12, 13, 18, 19, 21, 25]. Moreover, the normal forms of positional 2-person games with perfect information can be characterized by Proposition 3 [19, 20, 21]. Such a normal form is exactly the intersection matrix of the maximal cliques and stable sets of the corresponding graph, where the final positions (outcomes) of the game are in one-to-one correspondence with the vertices of this graph. See an example in Figure 3, where the monotone Boolean functions $F_S = 13 \vee 24$ and $F_C = (1 \vee 3)(2 \vee 4)$ corresponding to the hypergraphs $\mathcal{S} = \{(1, 3), (2, 4)\}$ and $\mathcal{C} = \{(1, 2), (2, 3), (3, 4), (4, 1)\}$ are read-once.

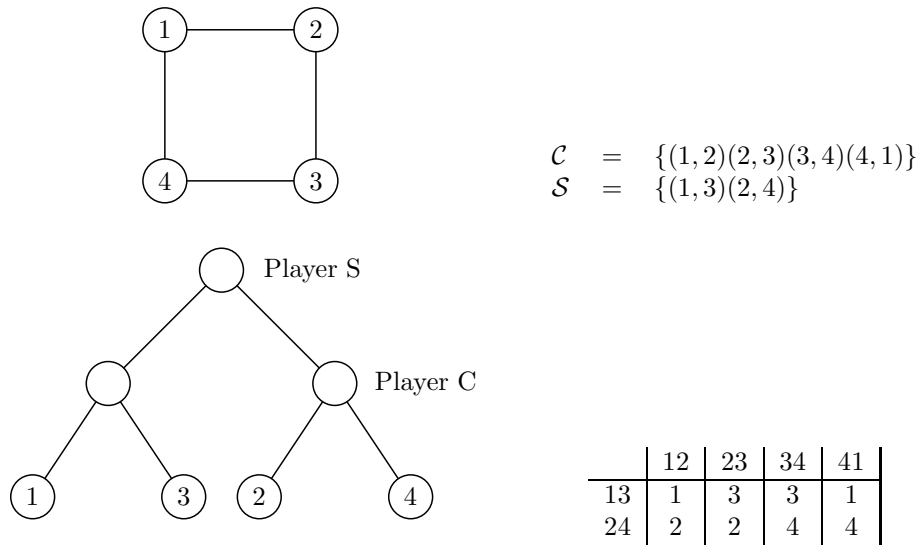

Figure 3: A P_4 -free graph and the corresponding positional and normal game forms

However, the absence of induced P_4 s is only sufficient but not necessary for the CIS-property to hold. Let a graph G contain an induced P_4 defined by $(v_1, v'_1), (v_2, v'_2), (v_1, v_2)$. The clique $\{v_1, v_2\}$ and stable set $\{v'_1, v'_2\}$ are disjoint. Hence, they cannot be maximal in G if it is a CIS-graph. In other words, G must contain a fifth vertex v_0 such that $(v_0, v_1), (v_0, v_2)$ are edges, while $(v_0, v'_1), (v_0, v'_2)$ are not. In this case we will say that P_4 is settled by v_0 , cf. [32]. Let us note that the graph induced by $\{v_0, v_1, v_2, v'_1, v'_2\}$ is a CIS-graph, see Figure 6.

Thus, every induced P_4 in a CIS-graph must be settled. This condition is necessary, as we argued above, yet, it is not sufficient, according to the following examples.

1.4 Combs and anti-combs

Given an integer $k \geq 2$, a *comb* (or k -comb) S_k is defined as a graph with $2k$ vertices k of which form a clique $C = \{v_1, \dots, v_k\}$, while the remaining k form a stable set $S = \{v'_1, \dots, v'_k\}$. In addition, S_k contains the perfect matching (v_i, v'_i) for $i = 1, \dots, k$, and there are no more edges in S_k . Let us note that graphs S_2 and P_4 are isomorphic. Furthermore,

S_3 contains 3 induced S_2 and all 3 are settled. More generally, S_k contains k induced S_{k-1} and they all are settled. Figure 4 shows S_k , for $k = 2, 3$, and 4.

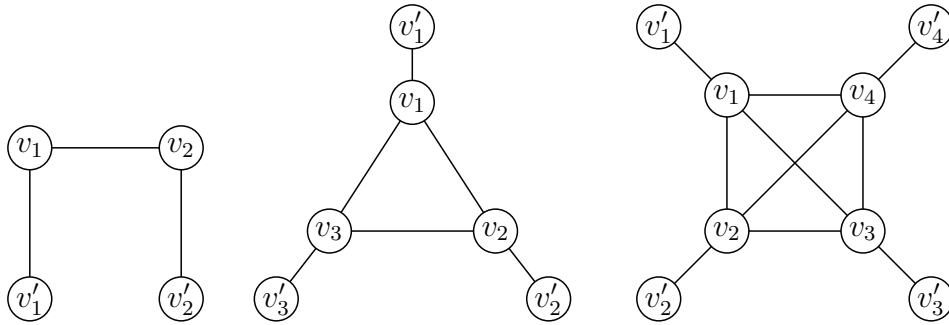

Figure 4: Combs S_k , for $k = 2, 3$ and 4

The complementary graph $\overline{S_k}$ is called an *anti-comb* (or k -anti-comb). Figure 5 shows $\overline{S_k}$ for $k = 2, 3$, and 4.

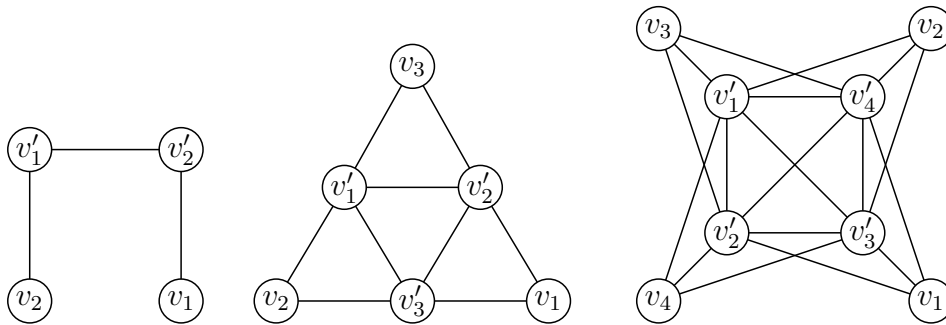

Figure 5: Anti-combs $\overline{S_k}$, for $k = 2, 3$ and 4.

Clearly, the sets S and C are switched in S_k and $\overline{S_k}$. It is also clear that combs and anti-combs are not CIS-graphs, since they contain a maximal clique C and stable set S that are disjoint. Hence, if a CIS-graph G contains an induced comb S_k (respectively, anti-comb $\overline{S_k}$) then it must be *settled*, that is, G must contain a vertex v_0 adjacent to each vertex of C and to no vertex of S . Thus, the following condition is necessary for the CIS-property to hold.

(COMB) Every induced comb and anti-comb must be settled in G .

Figures 6 and 7 show settled combs and anti-combs. It is easy to verify that they are complementary CIS-graphs. Hence, the corresponding intersection matrices are mutually transposed.

The following obvious properties of combs and anti-combs are worth summarizing:

- The 2-comb S_2 and 2-anti-comb $\overline{S_2}$ are isomorphic, while the k -comb S_k and k -anti-comb $\overline{S_k}$ are not isomorphic for $k > 2$.

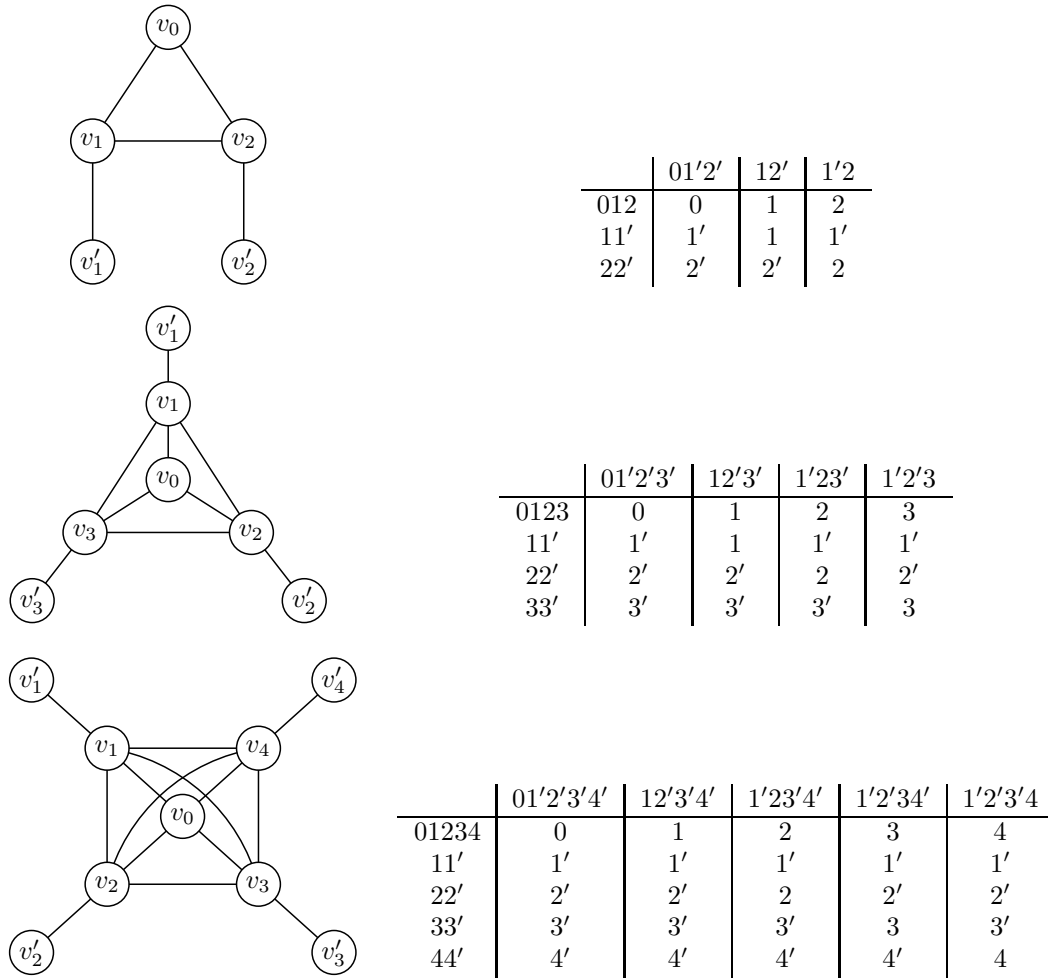

Figure 6: Settled combs S_k , for $k = 2, 3$ and 4 .

- The k -comb S_k contains $\binom{k}{m}$ induced m -combs S_m that are all settled in S_k , yet, it contains no induced m -anti-combs $\overline{S_m}$ for $m > 2$; respectively, the k -anti-comb $\overline{S_k}$ contains $\binom{k}{m}$ induced m -anti-combs $\overline{S_m}$ that are all settled in $\overline{S_k}$, yet, it contains no induced m -combs S_m for $m > 2$.
- The settled k -comb and anti-comb are complementary CIS-graphs.

Obviously, **COMB** is a necessary condition for the CIS-property to hold. Yet, it is not sufficient, as we will see in Section 1.5. Let us introduce the following stronger condition.

COMB(3, 3) There is no induced 3-comb or 3-anti-comb, and every induced 2-comb is settled in G .

Our main result claims that this stronger condition already implies the CIS-property.

Theorem 1. *A graph G is a CIS-graph whenever it satisfies **COMB(3, 3)**.*

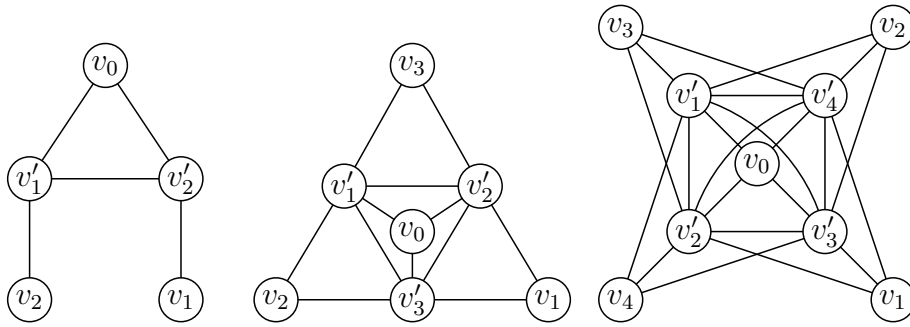

Figure 7: Settled anti-combs \overline{S}_k , for $k = 2, 3$ and 4 .

We give the proof in Section 2. It contains a complicated case analysis in which one of the cases is especially interesting and results in a remarkable graph that is “almost” a counterexample to Theorem 1. This graph $2\mathcal{P}$ (see Figure 8) consists of two identical copies of the Petersen graph induced by the vertices v_0, \dots, v_9 and v'_0, \dots, v'_9 respectively. Furthermore, (v'_i, v_j) is an edge if and only if (v_i, v_j) is not, for all $i \neq j$. Ten remaining pairs, (v_i, v'_i) , $i = 0, \dots, 9$, are uncertain, that is, configuration $2\mathcal{P}$ represents in fact 2^{10} possible graphs rather than one graph. The following properties of $2\mathcal{P}$ are easy to see.

- (a) $2\mathcal{P}$ is isomorphic to its complement.
- (b) $2\mathcal{P}$ is regular of “degree 9.5”, that is, each vertex is incident to 9 edges and belongs to one uncertain pair.
- (c) For every two vertices u, v there is an automorphism α of $2\mathcal{P}$ such that $\alpha(u) = v$.
- (d) None of the 2^{10} graphs of $2\mathcal{P}$ contains an induced 3-comb or 3-anti-comb.
- (e) Every induced 2-comb in all 2^{10} graphs of $2\mathcal{P}$ involves a pair v_i, v'_i for some $i = 0, \dots, 9$.

In fact, 36 induced 2-combs appear, whenever we substitute a pair v_i, v'_i by an edge (or by a non-edge). It is easy to see that none of these 2-combs can be settled by a vertex of $2\mathcal{P}$, and if it is settled by a new vertex then an unsettled 3-comb or 3-anti-comb always appears. Thus, the case under consideration does not lead to a counterexample, and a complete case analysis yields the proof of Theorem 1, see Section 2.

Four examples of CIS-graphs satisfying condition **COMB**(3, 3) are given in Figure 1.

It would be interesting to analyze the following relaxations of condition **COMB**(3, 3) that are still stronger than **COMB**. Given integers $i, j \geq 2$, we say that a graph G satisfies condition **COMB**(i, j) if all induced combs and anti-combs in G are settled and, moreover, G contains no induced S_i and \overline{S}_j . By a natural convention we have **COMB** = **COMB**(∞, ∞).

Clearly, condition **COMB**(2, 2) implies the CIS-property, since it means that the graph is P_4 -free. In fact, we have **COMB**(2, 2) \equiv **COMB**(2, i) \equiv **COMB**($i, 2$) for every $i \geq 2$,

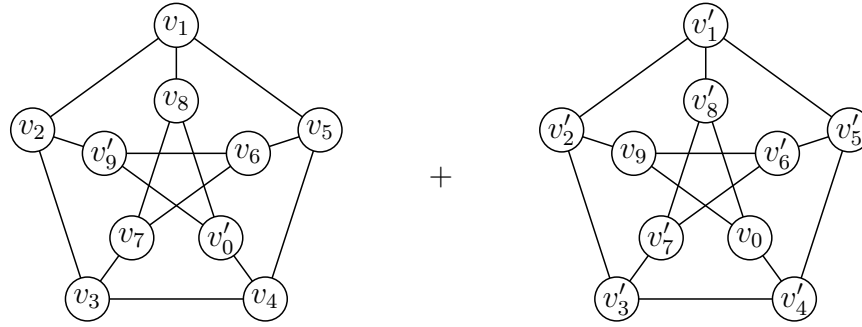

Figure 8: Graph $2\mathcal{P}$.

since the 2-comb $S_2 \equiv P_4$ is self-complementary and every comb and anti-comb contains an induced 2-comb. Furthermore, condition $\mathbf{COMB}(i, j)$ is monotone in the sense that it implies $\mathbf{COMB}(i', j')$ for all $i \leq i'$ and $j \leq j'$, and symmetric, in the sense that $\mathbf{COMB}(i, j)$ implies the CIS-property if and only if $\mathbf{COMB}(j, i)$ does (due to the fact that G is a CIS-graph if and only if its complement \overline{G} is a CIS-graph).

According to Theorem 1, condition $\mathbf{COMB}(3, 3)$ implies the CIS-property. However, it is not known whether $\mathbf{COMB}(4, 4)$ or $\mathbf{COMB}(3, j)$ for some $j \geq 4$ imply the CIS-property or not. Certainly, condition $\mathbf{COMB}(5, 4)$ does not, as the next section shows.

1.5 (n, k, ℓ) -graphs and their complements

The following graph $G = (V, E)$ was suggested by Ron Holzman in 1994. It has $\binom{5}{1} + \binom{5}{2} = 5 + 10 = 15$ vertices, where subsets $S = \{v_1, \dots, v_5\}$ and $C = \{v_{12}, \dots, v_{45}\}$ induce a stable set and clique, respectively; $V = C \cup S$ (hence, G is a split graph); furthermore, every pair (v_i, v_{ij}) , where $i, j = 1, \dots, 5$ and $i \neq j$, is an edge, and there are no more edges. Let us denote this graph by $G(5, 1, 2)$, see Figure 9.

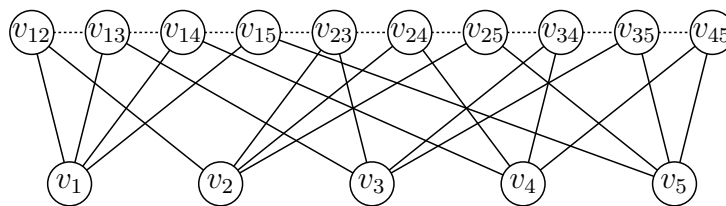

Figure 9: Graph $G(5, 1, 2)$ was constructed by Ron Holzman in 1994.

It is easy to verify that $G(5, 1, 2)$ contains no induced 5-combs and 4-anti-combs. In section 3 we will show that all induced combs and anti-combs in $G(5, 1, 2)$ are settled. For example, the 4-comb induced by vertices $(v_{12}, v_{13}, v_{14}, v_{15}, v_2, v_3, v_4, v_5)$ is settled by v_1 and the 3-anti-comb induced by $(v_{12}, v_{13}, v_{23}, v_1, v_2, v_3)$ is settled by v_{45} , etc. Thus, the graph

$G(5, 1, 2)$ satisfies condition **COMB**(5, 4), however, it is not a CIS-graph, since $C \cap S = \emptyset$. Let us notice that the settled extension of $G(5, 1, 2)$ is a CIS-graph, see Figure 10.

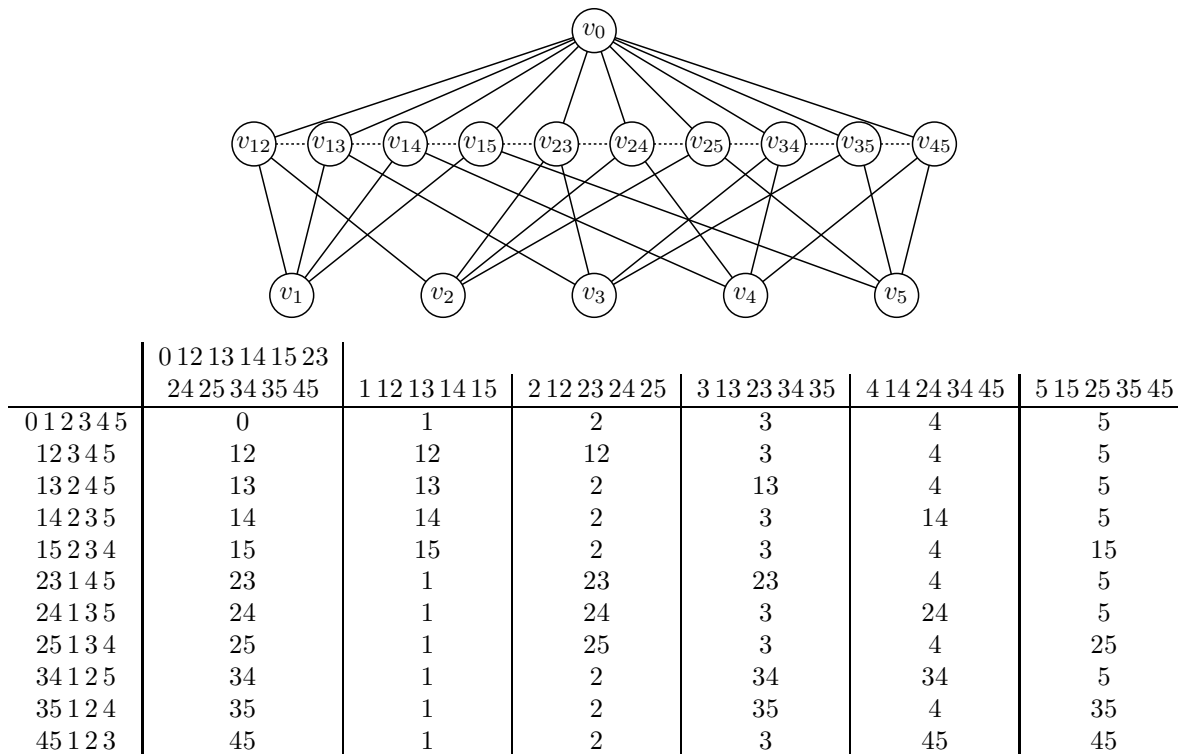

Figure 10: Settled $G(5, 1, 2)$.

We generalize the above example as follows. Given integers n, k, ℓ such that $n > k \geq 1$ and $n > \ell \geq 1$, consider a set S (respectively, C) consisting of $\binom{n}{k}$ (respectively, $\binom{n}{\ell}$) vertices labeled by k -subsets (respectively, by ℓ -subsets) of a ground n -set. Let us introduce the graph $G(n, k, \ell)$ on the vertex-set $C \cup S$ such that S is a stable set, C is a clique, and a vertex of S is adjacent to a vertex of C if and only if the corresponding k -set is either a subset or a superset of the corresponding ℓ -set. Obviously, $G(n, k, \ell)$ is not a CIS-graph, since $C \cap S = \emptyset$. However, some of these graphs satisfy the condition **COMB**, for example, $G(5, 1, 2)$. Moreover, $G(5, 1, 2)$ satisfies the stronger condition **COMB**(5, 4).

By definition, $G(n, 1, 1) = S_n$ is an n -comb and $G(n, n - 1, 1) = \overline{S_n}$ is an n -anti-comb. Furthermore, it is easy to see that

- (i) the graphs $G(n, k, \ell)$ and $G(n, n - k, n - \ell)$ are isomorphic.

Hence, without loss of generality we can assume that $k \leq \ell$ and even that $k < \ell$, since $G(n, k, k)$ is just a comb $S_{\binom{n}{k}}$. Then, from the simple fact that a set contains an element if and only if the complementary set does not contain it, we derive

- (ii) the graphs $G(n, k, 1)$ and $G(n, 1, n - k)$ are complementary.

Thus, the graphs $G(n, k, n-1)$ and $G(n, n-k, 1)$ are isomorphic by (i) and complementary to $G(n, 1, k)$ by (ii). Hence, without loss of generality we can assume that $\ell \leq n-2$. Summarizing, we will assume in the sequel that

$$1 \leq k < \ell \leq n-2. \quad (1.1)$$

In section 3 we will prove the following two claims analyzing the existence of unsettled anti-combs and combs in $G(n, k, \ell)$.

Theorem 2.

(i) *Each induced anti-comb in $G(n, k, \ell)$ is settled whenever*

$$n > \frac{k+1}{k}\ell.$$

(ii) *An unsettled induced anti-comb exists in $G(n, k, \ell)$ whenever*

$$k + \ell \leq n \leq \frac{k+1}{k}\ell.$$

Theorem 3.

(a) *Each induced comb is settled in $G(n, 1, \ell)$, and it is settled in $G(n, 2, \ell)$ whenever*

$$n < 2\ell - 3.$$

(b) *An unsettled induced comb exists in $G(n, k, \ell)$ for $k \geq 2$ whenever*

$$n \geq \frac{k}{k-1}\ell - \frac{r}{k-1} \quad \text{or} \quad n = \frac{k}{k-1}\ell - \frac{r}{k-1} - 1 \quad \text{and} \quad \ell > r + k^2 - k,$$

where $r \equiv \ell \pmod{k-1}$ and $r \in \{2, 3, \dots, k\}$.

Let us denote by \mathbf{G} the subfamily of graphs $G(n, k, \ell)$ whose induced combs and anti-combs are all settled and n, k, ℓ satisfy (1.1).

Corollary 2. *For $k=1$ and $k=2$ the membership in \mathbf{G} is characterized as follows:*

$$\begin{aligned} G(n, 1, \ell) \in \mathbf{G} & \quad \text{iff} \quad n > 2\ell \\ G(n, 2, \ell) \in \mathbf{G} & \quad \text{iff} \quad 2\ell - 3 > n > (3/2)\ell. \end{aligned}$$

Proof. By (1.1) we have $n \geq \ell + 2 \geq \ell + k$, whenever $k \leq 2$, and thus, by Theorem 2, all induced anti-combs are settled in $G(n, k, \ell)$ for $k \leq 2$ if and only if $n > \frac{k+1}{k}\ell$. This and (a) of Theorem 3 then implies the claim for $k = 1$.

If $k = 2$ then $G(n, 2, \ell)$ has an unsettled comb, by (b) of Theorem 3, if $n \geq 2\ell - 2$ or if $n = 2\ell - 3$ and $\ell > 4$, since $r = 2$ in this case. However, if $n = 2\ell - 3$ then $\ell \geq 5$ by (1.1). Hence, the second condition holds automatically, and therefore by (a) and (b) of Theorem 3, we can conclude that $G(n, 2, \ell)$ has an unsettled comb if and only if $n \geq 2\ell - 3$. \square

Thus, for $k = 1$ we get $\{G(5, 1, 2), G(6, 1, 2), G(7, 1, 2), G(7, 1, 3), \dots\} \subseteq \mathbf{G}$ and for $k = 2$ we get $\{G(14, 2, 9), G(16, 2, 10), G(17, 2, 11), G(18, 2, 11), G(19, 2, 12), G(20, 2, 13), \dots\} \subseteq \mathbf{G}$.

Remark 3. Notice that conditions (i) and (ii) of Theorem 2 provide an almost complete characterization of the existence of unsettled anti-combs in $G(n, k, \ell)$. However, it is not clear if condition $n \geq k + \ell$ in part (ii) is necessary. Note that if $k \leq 2$, then this condition holds automatically by (1.1). For instance, we do not know if $G(8, 3, 6)$ has an unsettled anti-comb. Computer experiments show that there are no unsettled m -anti-combs for $m \leq 10$. In any case, $G(8, 3, 6)$ has an unsettled 6-comb, by Theorem 3.

Let us also note that we know much less about combs. For instance, we could only treat the case of $k \leq 2$ in (a) of Theorem 3, though we conjecture that a similar claims can hold for all k . For example, $G(10, 3, 8)$ is the smallest graph for which we do not know if it contains an unsettled comb or anti-comb.

Based on the proofs of the above theorems and on several numerical examples we conjecture that membership in \mathbf{G} can be characterized by inequalities of the approximate form

$$\frac{k}{k-1}\ell + O(k) \geq n \geq \frac{k+1}{k}\ell - O(k).$$

This is certainly the case for $k \leq 2$, by Corollary 2.

By definition, in a graph $G = G(n, k, \ell) \in \mathbf{G}$, as well as in its complement \overline{G} , all induced combs and anti-combs are settled, that is, both G and \overline{G} satisfy the condition **COMB**. Let us notice however that \overline{G} is not an (n, k, ℓ) -graph unless $k = 1$. (Recall that $G(n, 1, \ell)$ and $G(n, n - \ell, 1)$ are complementary.)

It seems that every non-CIS-graph satisfying **COMB** contains either an induced $G(n, k, \ell) \in \mathbf{G}$ or its complement. At least, we have no counterexample for this claim.

Let us add that, unlike the case of combs and anti-combs, one graph from \mathbf{G} may contain another as an unsettled induced subgraph. For example, $G(6, 1, 2)$ contains an unsettled induced $G(5, 1, 2)$, while in $G(7, 1, 2)$ all induced $G(5, 1, 2)$ are settled. Yet, in $G(7, 1, 2)$ there is an unsettled induced $G(6, 1, 2)$. Vice versa, in $G(7, 1, 3)$ each induced $G(6, 1, 2)$ is settled but there are unsettled induced $G(5, 1, 2)$. Further, in $G(8, 1, 3)$, all induced $G(5, 1, 2)$ and $G(7, 1, 2)$ are settled but there are unsettled induced $G(6, 1, 2)$ and $G(7, 1, 3)$. Due to this “non-transitivity”, in order to enforce the CIS-property for a graph G , it seems easier to assume that all induced subgraphs from \mathbf{G} as well as their complements are settled in G . Of course, it is even simpler to assume that G does not contain such subgraphs at all.

Conjecture 2. *If G contains no induced $G(5, 1, 2)$ nor its complement $G(5, 3, 1)$ and all induced combs and anti-combs are settled in G then G is a CIS-graph.*

We remark here that $G(n, k, l)$ contains an induced $G(n', k', l')$ whenever $n' \leq n$, $k' \leq k$, and $l' \leq l$.

Remark 4. *Let us note that CIS-graphs and perfect graphs look somewhat similar. Both classes are closed with respect to complementation and substitution. Odd holes and anti-holes are similar to combs and anti-combs. The following two tests look similar too: whether G contains an induced odd hole or anti-hole and whether G contains an induced unsettled comb or anti-comb. It seems that CIS-graphs, like perfect graphs, may allow a simple characterization and a polynomial recognition algorithm (that may be very difficult to obtain, though).*

However, there are dissimilarities, too. The property of perfectness is hereditary, unlike the CIS-property. Also, there are non-CIS-graphs in which all induced combs and anti-combs are settled. (By Conjecture 2, every such graph contains an induced $G(5, 1, 2)$ or its complement $G(5, 3, 1)$.)

Remark 5. *CIS-graphs were recently mentioned (under the name of stable graphs) in [38], where it is shown that recognition of stable graphs is a special case of a difficult problem (strongly bipartite bihypergraph recognition problem) introduced in this paper. Based on this observation, the authors conjecture that recognition of stable graphs is co-NP-complete. However, we conjecture that this problem is polynomial.*

The following relaxation of the CIS-property was considered in [26] and [36].

Triangle condition: *for every maximal stable set S and every edge (u, v) such that $u, v \notin S$ there exists a vertex $w \in S$ such that vertices u, v, w induce a clique.*

Obviously, each CIS-graph has this property.

1.6 Gallai's and CIS- d -graphs.

Let us generalize the concept of a CIS-graph as follows. For a given integer $d \geq 2$, a complete graph whose edges are colored by d colors $\mathcal{G} = (V; E_1, \dots, E_d)$ is called a d -graph. To a given d -graph \mathcal{G} let us assign a family of d hypergraphs $\mathcal{C} = \mathcal{C}(\mathcal{G}) = \{\mathcal{C}_i \mid i = 1, \dots, d\}$ on the common vertex-set V , where the hyperedges of \mathcal{C}_i are all inclusion maximal subsets of V containing no edges of color i . We say that \mathcal{G} is a *CIS- d -graph* (has the *CIS- d -property*) if $\bigcap_{i=1}^d C_i \neq \emptyset$ for all selections $C_i \in \mathcal{C}_i$ for $i = 1, \dots, d$. Obviously, such an intersection can contain at most one vertex. If $d = 2$ then we obtain the original concept of *CIS-graphs*. (More accurately, CIS-2-graph is a pair of two complementary CIS-graphs.) Similarly to CIS-graphs, CIS- d -graphs also satisfy a natural requirement that can be considered as a generalization of settling. Assume that X_i is a clique in the subgraph $G_i = (V, \cup_{j \neq i} E_j)$ for $i = 1, \dots, d$, and that $\bigcap_{i=1}^d X_i = \emptyset$. Then, these cliques cannot all be maximal and, hence, there must be a vertex $x \in V$ such that for every $i = 1, \dots, d$ and $y \in X_i$ we have $(x, y) \notin E_i$. We will say in this case that $\{X_1, \dots, X_d\}$ are *settled* by x .

Given a CIS- d -graph \mathcal{G} , let us assign to it a d -dimensional table $g = g(\mathcal{G})$, that is, a mapping $g : \mathcal{C}_1 \times \dots \times \mathcal{C}_d \rightarrow V$ defined by the rule: $g(C_1, \dots, C_d) = v$ whenever $\{v\} = \bigcap_{i=1}^d C_i$. Let us observe that this d -dimensional array is partitioned by the elements of V into $n = |V|$ sub-arrays called *boxes*, since the following implication holds:

if $g(C'_1, \dots, C'_d) = g(C''_1, \dots, C''_d) = v$, then v belongs to all these $2d$ sets, and hence, $g(C_1, \dots, C_d) = v$ for all 2^d choices $C_i \in \{C'_i, C''_i\}$, $i = 1, \dots, d$.

Let us further introduce two special edge colored graphs. Let Π denote the 2-colored graph whose both chromatic components form a P_4 , that is, $V = \{v_1, v_2, v_3, v_4\}$; $E_1 = \{(v_1, v_2), (v_2, v_3), (v_3, v_4)\}$, and $E_2 = \{(v_2, v_4), (v_4, v_1), (v_1, v_3)\}$. Furthermore, let Δ denote the 3-colored triangle, for which $V = \{v_1, v_2, v_3\}$, $E_1 = \{(v_1, v_2)\}$, $E_2 = \{(v_2, v_3)\}$, and $E_3 = \{(v_3, v_1)\}$. Figure 12 illustrates these graphs.

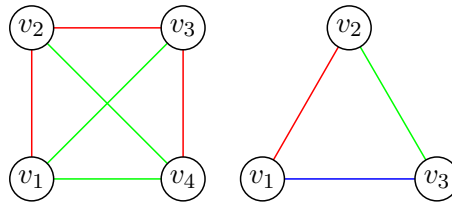

Figure 11: Colored Π and Δ .

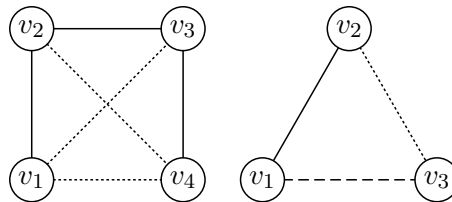

Figure 12: Colored Π and Δ (in black and white for printing).

Proposition 4 ([19, 21]). *Every Π - and Δ -free d -graph is a CIS- d -graph.* □

In fact, a stronger claim holds.

Proposition 5 ([19, 20, 21]). *A d -graph \mathcal{G} is Π - and Δ -free if and only if the corresponding mapping $g(\mathcal{G})$ defines the normal form of a positional d -person game with perfect information whose final positions (outcomes of the game) are in one-to-one correspondence with the vertices of \mathcal{G} .* □

For example, let us consider the Π - and Δ -free 3-graph \mathcal{G} given in Figure 13. For this graph we have $\mathcal{C}_1 = \{(1, 3), (2, 4)\}$, $\mathcal{C}_2 = \{(1, 2, 4), (2, 3, 4)\}$, and $\mathcal{C}_3 = \{(1, 2, 3), (1, 3, 4)\}$. The mapping $g(\mathcal{G})$ and the corresponding positional game are shown in Figure 13.

Another example of a Π - and Δ -free 3-graph is given in Figure 14. In this case $\mathcal{C}_1 = \{(1), (2, 3, 4)\}$, $\mathcal{C}_2 = \{(1, 3), (1, 2, 4)\}$, and $\mathcal{C}_3 = \{(1, 2, 3), (1, 3, 4)\}$. The mapping $g(\mathcal{G})$ and the corresponding positional game are shown in Figure 14.

Of course, the condition that a d -graph \mathcal{G} must be Π - and Δ -free is only sufficient but not necessary for the CIS- d property to hold. On the other hand, the following condition is clearly

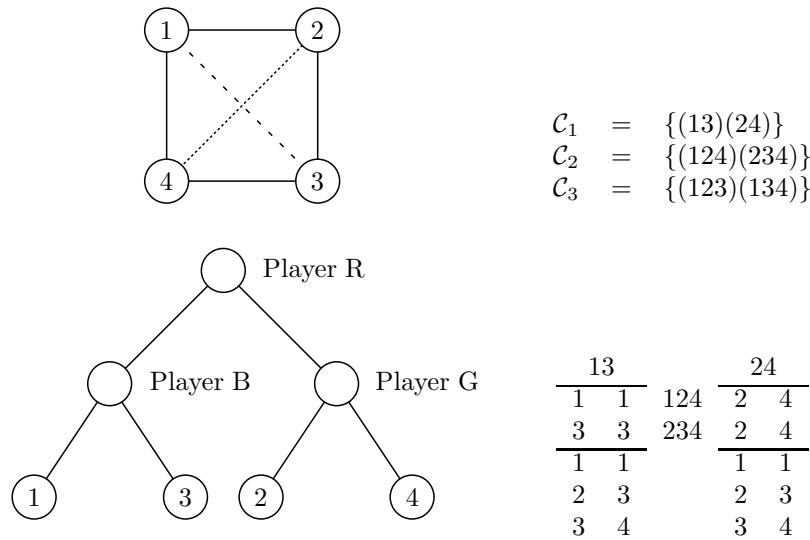

Figure 13: A Π - and Δ -free 3-graph and the corresponding positional and normal game forms.

necessary. Given a d -graph $\mathcal{G} = (V; E_1, \dots, E_d)$ and a partition $P_1 \cup \dots \cup P_\delta = \{1, \dots, d\}$ of its colors, let us define a δ -graph $\mathcal{G}' = (V; E'_1, \dots, E'_\delta)$ by setting $E'_i = \cup_{j \in P_i} E_j$, $i = 1, \dots, \delta$ and call \mathcal{G}' the δ -projection of \mathcal{G} .

Proposition 6. *Let \mathcal{G} be a CIS- d -graph whose set of colors $\{1, \dots, d\}$ is partitioned into δ non-empty subsets ($2 \leq \delta \leq d$) then the corresponding δ -graph \mathcal{G}' is a CIS- δ -graph.*

In particular, in case $\delta = 2$ we must get two complementary CIS-graphs.

The following conjecture is open since 1978.

Conjecture 3. *([19]) Every CIS- d -graph is Δ -free.*

By Proposition 6, it would suffice to prove this conjecture for $d = 3$. In this case, it was verified up to $n = 12$ vertices by a computer code written by Steven Jaslar in 2003. We will consider this conjecture in Section 4 and show that, similarly to combs and anti-combs, all Δ s in a CIS- d -graph must be settled, and it takes two vertices to settle a Δ (see Section 4.2). Although there are d -graphs in which all Δ s are settled, yet, it seems impossible to have settled simultaneously all combs and anti-combs in all 2-projections of these d -graphs, a condition that is necessary by Proposition 6.

In the literature Δ -free d -graphs are called *Gallai's graphs*, since they were introduced by Gallai in [16]. We will call them Gallai's d -graphs which is more accurate. They are well studied [1, 8, 9, 10, 14, 24, 27, 28]. Conjecture 3 means that CIS- d -graphs form a subfamily of Gallai's d -graphs. Next, we will characterize Gallai's CIS- d -graphs in terms of CIS-graphs. Hence, to characterize CIS- d -graphs it would suffice to do it for $d = 2$ and prove Conjecture 3.

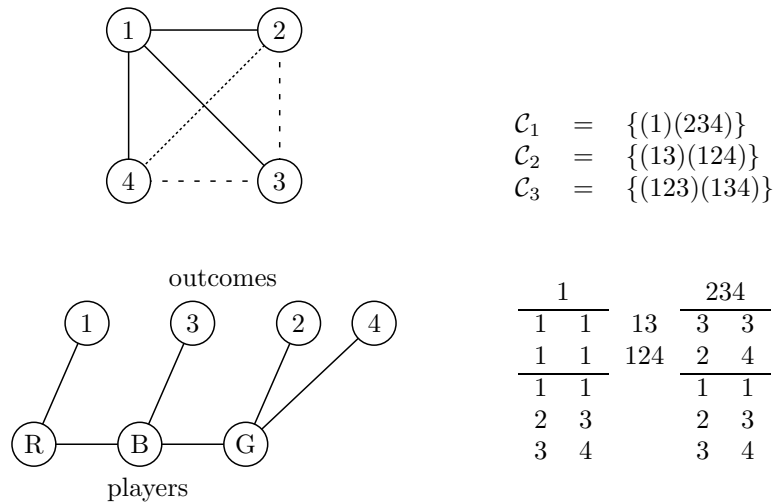

Figure 14: A Π - and Δ -free 3-graph and the corresponding positional and normal game forms.

First, let us note that both Gallai’s and CIS- d -graphs are closed under substitution. (For Gallai’s d -graphs this is well known [8, 24].) Moreover, the inverse claims hold too.

Proposition 7. *Let us substitute a d -graph \mathcal{G}'' for a vertex v of a d -graph \mathcal{G}' and denote the obtained d -graph by $\mathcal{G} = \mathcal{G}(\mathcal{G}', v, \mathcal{G}'')$. Then \mathcal{G} is a Gallai (respectively, CIS-) d -graph if and only if both \mathcal{G}' and \mathcal{G}'' are Gallai’s (respectively, CIS-) d -graphs.*

In case $d = 2$ this proposition implies the similar property for CIS-graphs.

Proposition 8. *Let us substitute a graph G'' for a vertex v of a graph G' and denote the obtained graph by $G = G(G', v, G'')$. Then G is a CIS-graph if and only if both G' and G'' are CIS-graphs. \square*

Let us recall, however, that CIS- d -property is not hereditary, that is, an induced subgraph of a CIS- d -graph may have no CIS- d -property. In particular, for $d = 2$, this means that an induced subgraph of a CIS-graph may have no CIS-property.

Here and in the sequel we assume that the set of colors $[d] = \{1, \dots, d\}$ is the same for all considered d -graphs, while some chromatic components may be trivial (edge-empty). For example, by a 2-graph we mean a d -graph with at most 2 non-trivial chromatic components.

It is known that each Gallai d -graph can be obtained from 2-graphs by substitutions. More precisely, the following claim holds.

Proposition 9 (Cameron and Edmonds, [8]; Gyárfás and Simonyi, [24]). *For each Gallai d -graph \mathcal{G} there exist a 2-graph \mathcal{G}_0 with n vertices and n Gallai d -graphs $\mathcal{G}_1, \dots, \mathcal{G}_n$ such that \mathcal{G} is obtained by substituting $\mathcal{G}_1, \dots, \mathcal{G}_n$ for n vertices of \mathcal{G}_0 .*

In [24], this claim is derived from the following Lemma.

Lemma 1 ([16], [8], and [24]). *Every Gallai d -graph $\mathcal{G} = (V; E_1, \dots, E_d)$ with $d \geq 3$ has a color $i \in [d]$ that does not span V , or in other words, the graph $G_i = (V, E_i)$ is not connected.*

Remark 6. *It is interesting to compare Lemma 1 with the following Lemma from [19, 21]. If a d -graph \mathcal{G} is Π - and Δ -free then there exists a unique color $i \in [d]$ such that the complement of the i -th chromatic component, $\overline{G_i}$, is disconnected.*

Gyárfás and Simonyi remark that Lemma 1 “is essentially a content of Lemma (3.2.3) in [16]” and they derive Proposition 9 from it as follows. If $d \leq 2$ we are done. Otherwise, we have a color $i \in [d]$ such that graph $G_i = (V, E_i)$ is disconnected. It is not difficult to show that for each two of its connected components all edges between them are of the same color j (clearly, $j \neq i$), since otherwise a Δ appears.

Collapsing these components into vertices we get a smaller $(d - 1)$ -graph which is still Δ -free, by Proposition 7. By induction, $\mathcal{G}_1, \dots, \mathcal{G}_n$ and \mathcal{G}_0 can be constructed as required. \square

Moreover, applying the above decomposition recursively, we can represent an arbitrary Gallai d -graph $\mathcal{G} = (V; E_1, \dots, E_d)$ by a substitution-tree $T(\mathcal{G})$ whose leaves are associated to 2-graphs. If $d \leq 2$ then \mathcal{G} itself is a 2-graph and $T(\mathcal{G})$ is reduced to one vertex. If $d \geq 3$ then, by Lemma 1, there is a color $i \in [d]$ such that the i -th component $G_i = (V, E_i)$ does not span V , or in other words, it is disconnected. Let $W \subset V$ be a connected component of G_i . Furthermore, let $G'' = G[W]$ be the subgraph of \mathcal{G} induced by W , while G' be obtained from \mathcal{G} by contracting W to a single new vertex v . Then, as it was shown above, substituting \mathcal{G}'' for v in \mathcal{G}' we get $\mathcal{G} = \mathcal{G}(\mathcal{G}', v, \mathcal{G}'')$; see Figure 15. If \mathcal{G}' (or \mathcal{G}'') is a 2-graph then it becomes a leaf of $T(\mathcal{G})$. Otherwise, if \mathcal{G}' (or \mathcal{G}'') has more than 2 non-trivial chromatic components, we decompose it further in the same way until only 2-graphs remain. They are the leaves of the obtained decomposition tree $T(\mathcal{G})$, as required.

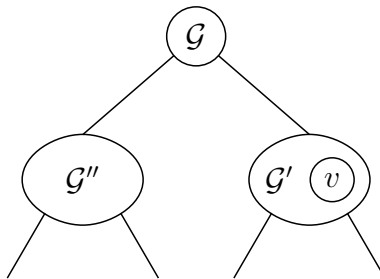

Figure 15: Decomposing \mathcal{G} by the tree $T(\mathcal{G})$; substituting \mathcal{G}'' for v in \mathcal{G}' to get \mathcal{G} .

It is well-known that decomposing a given graph into connected components can be executed in linear time. Hence, given \mathcal{G} , its decomposition tree $T(\mathcal{G})$ can be constructed in linear time, too.

Remark 7. *As defined above, tree $T(\mathcal{G})$ is not unique, since several chromatic components of \mathcal{G} may be disconnected and any connected component of any chromatic component can be chosen as W for the decomposition. Let us note, however, that the corresponding vertex sets are nested. More precisely, if E_i^a, E_j^b are connected components of colors $i, j \in [d]$ then the*

corresponding vertex-sets $V_i^a, V_j^b \subseteq V$ are either disjoint, or one of them is a subset of the other. Yet, the latter case cannot take place when $i = j$.

Let us also note that in general $T(\mathcal{G})$ can be extended further, since some 2-graphs also can be decomposed by substitution. Obviously, the decomposition of a 2-graph $\mathcal{G} = (V; E_1, E_2)$ is reduced to a decomposition of a graph, namely, of a chromatic component, $G_1 = G(V, E_1)$ or $G_2 = G(V, E_2)$.

In general, decomposing graphs (as well as d -graphs, digraphs, Boolean functions, etc.) by substitution is known as their modular decomposition. A module is a set $X \subseteq V$ such that no member of $V \setminus X$ distinguishes members of X . A set family \mathcal{F} is called decomposable if $X \cap Y, X \cup Y, X \setminus Y, Y \setminus X$, and $X \Delta Y = (X \setminus Y) \cup (Y \setminus X)$ are in \mathcal{F} whenever $X, Y \in \mathcal{F}$ and $X \cap Y \neq \emptyset$. Möring [34] proved that the family of modules is decomposable and hence, there is a unique canonical modular decomposition tree.

In general, modular decomposition is more complicated than decomposition of Gallai's d -graphs. There have been a number of $O(n^4), O(n^3), O(mn), O(n^2), O(n+m \log n)$ algorithms. Finally, $O(m+n)$ algorithms were given by Cournier and Habib [11] and McConnell and Spinrad [33]. Some linear time algorithms work for graphs, d -graphs, digraphs, and Boolean functions. See [6, 7, 33, 34, 35] for a survey on modular decomposition.

We make use of the decomposition tree $T(\mathcal{G})$ to recognize whether \mathcal{G} is a CIS- d -graph. Obviously, by Propositions 7, we can extend Proposition 9 as follows.

Proposition 10. *A Gallai d -graph \mathcal{G} has the CIS- d -property if and only if all $n+1$ d -graphs $\mathcal{G}_1, \dots, \mathcal{G}_n$ and \mathcal{G}_0 from Proposition 9 have this property. \square*

Thus, every Gallai's CIS- d -graph can be obtained from CIS-2-graphs by recursive substitutions, and hence, a characterization or polynomial recognition algorithm of CIS-graphs would provide one for the Gallai CIS- d -graphs too.

From Propositions 6, 9, and 10 we will derive the following two claims.

Proposition 11. *A Gallai d -graph \mathcal{G} is a CIS- d -graph if and only if all d of its chromatic components are CIS-graphs.*

The “only if” part follows from Proposition 6 and “if” part can be strengthened as follows.

Proposition 12. *Given a Gallai d -graph \mathcal{G} such that at least $d-1$ of its d chromatic components are CIS-graphs, then \mathcal{G} is a CIS- d -graph.*

In particular, the remaining chromatic component of \mathcal{G} must be a CIS-graph.

In the next subsection we generalize the last claim by showing that it holds not only for CIS-graphs but also for perfect graphs and, in fact, for every family of graphs satisfying some simple requirements.

Yet, of course, it is essential that \mathcal{G} is a Gallai d -graph. For example, let us consider a 3-graph \mathcal{G} in Figure 16. Graphs G_1 and G_2 are isomorphic, each of them is a settled 2-comb with one isolated vertex. Hence, they are CIS-graphs. Yet, G_3 is not, since the stable set $S = \{2, 3, 5, 6\}$ and clique $C = \{1, 4\}$ are disjoint. However, \mathcal{G} is not Gallai's 3-graph, for example, $\{5, 6, 1\}$ as well as $\{1, 2, 3\}$ is a Δ .

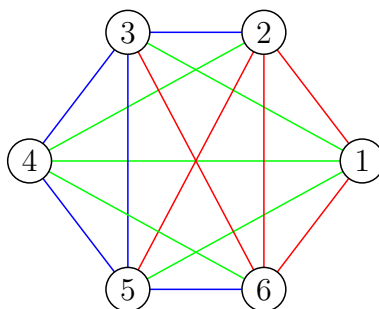

Figure 16: A non-Gallai 3-graph in which G_1 and G_2 are CIS-graphs, while G_3 is not.

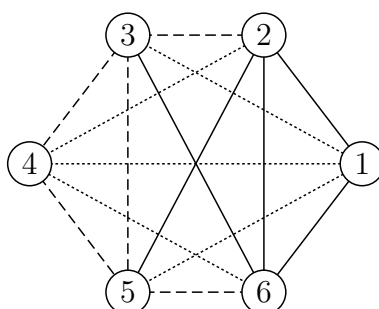

Figure 17: A non-Gallai 3-graph in which G_1 and G_2 are CIS-graphs, while G_3 is not (in black and white for printing).

1.7 Extending Cameron-Edmonds-Lovász' Theorem

Cameron, Edmonds, and Lovász [9] proved the statement similar to Proposition 12 for perfect graphs: given a Gallai d -graph, if at least $d-1$ of its chromatic components are perfect graphs, then the remaining component is a perfect graph, too. Later, Cameron and Edmonds [8] showed that, in fact, the statement holds for any family of graphs that is closed under: (i) substitution, (ii) complementation, and (iii) taking induced subgraphs. For example, it holds for P_4 -free graphs, or in other words, for the components of Π - and Δ -free d -graphs [19].

However, CIS-graphs satisfy only (i) and (ii) but not (iii). Nevertheless, the statement holds for them too; see Proposition 12.

In general, one can substitute the following property for (iii).

Let us say that a family of graphs (or d -graphs) \mathcal{F} is *exactly closed under substitution* $G = G(G', v, G'')$ whenever $G \in \mathcal{F}$ if and only if both G' and G'' belong to \mathcal{F} .

For example, CIS-graphs are exactly closed under substitution, by Propositions 8, and both, Gallai's and CIS- d -graphs, by Propositions 7.

Proposition 13. *If \mathcal{F} is closed under substitution and taking induced subgraphs then \mathcal{F} is exactly closed under substitution.*

Proof. Indeed, if $G = G(G', v, G'')$ then both G' and G'' are induced subgraphs of \mathcal{G} . □

We say that the family of graphs \mathcal{F} has the *CES-property* and call it a *CES-family* if \mathcal{F} is closed under complementation and exactly closed under substitution.

For example, the families of perfect graphs and CIS-graphs have the CES-property.

We strengthen Cameron-Edmonds' theorem as follows.

Theorem 4. *Let \mathcal{F} be a CES-family of graphs and $\mathcal{G} = (V; E_1, \dots, E_d)$ be a Gallai d -graph such that at least $d - 1$ of its chromatic components, say, $G_i = (V, E_i)$ for $i = 1, \dots, d - 1$, belong to \mathcal{F} . Then*

(a) *the last component $G_d = (V, E_d)$ is in \mathcal{F} too, and moreover,*

(b) *all 2^d projections of \mathcal{G} belong to \mathcal{F} , that is, for each subset $I \subseteq [d] = \{1, \dots, d\}$ the graph $G_I = (V, \cup_{i \in I} E_i)$ is in \mathcal{F} .*

We will prove this Theorem in Section 4.1. By Proposition 13, part (a) implies Cameron-Edmonds' theorem. Since CIS-graphs form a CES-family, we obtain the following claim.

Corollary 3. *Let $\mathcal{G} = (V; E_1, \dots, E_d)$ be a Gallai d -graph such that at least $d - 1$ of its chromatic components are CIS-graphs. Then the remaining chromatic component of \mathcal{G} is a CIS-graph too; hence, \mathcal{G} is a CIS- d -graph and all its 2^d projections are CIS-graphs. \square*

1.8 On families of graphs closed with respect to substitution

To get more examples of CES-families let us, first, consider hereditary classes. Each such class is a family of graphs \mathcal{F} defined by a family, finite or infinite, of forbidden subgraphs \mathcal{F}' . By definition, $G \in \mathcal{F}$ if and only if G contains no induced subgraph isomorphic to a $G' \in \mathcal{F}'$.

Let us call a graph (or d -graph) G *substitution-prime* (or just, prime, for brevity) if it is not decomposable by substitution, or more precisely, if $G = G(G', v, G'')$ for no G', G'' and v , except for two trivial cases: ($G = G'$ and $V(G'') = \{v\}$) or ($G = G''$ and $V(G') = \{v\}$).

Suppose that G is decomposable, $G = G(G', v, G'')$. Then, as we already mentioned, both G' and G'' are induced subgraphs of G . Hence, if G' or G'' contains an induced subgraph G_0 then G also contains it. However, G may contain G_0 even if G' and G'' do not. Yet, clearly, in this case G_0 is not substitution-prime. Thus, for both, graphs and d -graphs, we obtain the following statement.

Proposition 14. *Family \mathcal{F} is exactly closed under substitution if all (d -)graphs in \mathcal{F}' are substitution-prime. \square*

The inverse holds too if we assume (by the way, without any loss of generality) that no (d -)graph of \mathcal{F}' contains another one as an induced subgraph. Thus, \mathcal{F} is a CES-family (and, hence, it satisfies all conditions of Theorem 4) whenever \mathcal{F}' is closed under complementation ($G \in \mathcal{F}'$ if and only if $\overline{G} \in \mathcal{F}'$) and \mathcal{F}' contains only substitution-prime graphs.

For example, these two properties hold for the odd holes and anti-holes. In this case, \mathcal{F} is the family of Berge graphs. Thus, Theorem 4 and the Strong Perfect Graph Theorem imply the Cameron-Edmonds-Lovász Theorem [9]. Of course, it can be proved simpler: first,

show that perfect graphs are exactly closed under substitution, [30], and then apply Lovász' perfect graph theorem, [29, 30], instead of the strong one.

Another example is provided by the family \mathcal{F} of P_4 -free graphs. In this case $\mathcal{F}' = \{P_4\}$ and all conditions of Theorem 4 hold, since P_4 is self-complementary and prime.

Remark 8. *Moreover, in this case, it is easy to verify directly claims (a) and (b) of Theorem 4, see [19]. The following implication is instrumental: if a d -graph $\mathcal{G} = (V; E_1, \dots, E_d)$ is Π - and Δ -free then every its 2-projection $\mathcal{G}' = (V; E'_1, E'_2)$ is Π -free too.*

A similar example is given by the family \mathcal{F} of A -free graphs. In this case $\mathcal{F}' = \{A\}$, where A is the settled P_4 (or in other words, settled 2-comb, or bull-graph). Like P_4 , it is also self-complementary and substitution-prime.

However, if \mathcal{F}' contains a decomposable graph, e.g., C_4 , then \mathcal{F} may be not closed under substitution. For example, let $\mathcal{F}' = \{C_4, \overline{C_4}\}$ and consider the Gallai 3-graph in Figure 13. Two of its chromatic components belong to \mathcal{F} , while the third one, C_4 , does not.

As another example, let us consider $\mathcal{F}' = \{C_4, \overline{C_4}, C_5\}$. By [15], \mathcal{F} is the family of split graphs. This family is self-complementary, yet, it is not closed under substitution. Indeed, substituting, for example, a non-edge for the middle vertex of P_3 we get C_4 .

There are also non-hereditary families of graphs (respectively, d -graphs) closed under substitution; for example, CIS-graphs (respectively, CIS- d -graphs). It is not difficult to give more examples of such families and even to characterize them. Given a family \mathcal{F}' , finite or infinite, of (d -)graphs, let us denote by $cl(\mathcal{F}')$ its closure with respect to substitution.

Proposition 15. *A family \mathcal{F} of (d -)graphs is exactly closed under substitution if and only if $\mathcal{F} = cl(\mathcal{F}')$, where \mathcal{F}' is a family, finite or infinite, of substitution-prime (d -)graphs. Furthermore, \mathcal{F} is closed under complementation whenever \mathcal{F}' is.*

Proof. The second claim makes sense only for graphs and it is obvious. The first one follows from uniqueness of the canonical modular decomposition [34]. \square

The obtained family $\mathcal{F} = cl(\mathcal{F}')$ is not hereditary if and only if there are substitution-prime (d -)graphs $G \in \mathcal{F}'$ and $G' \notin \mathcal{F}'$ such that G' is an induced subgraph of G . For example, let $\mathcal{F}' = \{A\}$ contains only the bull-graph A then $\mathcal{F} = cl(\mathcal{F}')$ contains no 2-comb.

However, the characterization of the CES-families by Proposition 15 is not constructive. For example, the substitution-prime perfect or CIS-graphs form infinite families that are difficult to describe explicitly.

1.9 Almost CIS- d -graphs

A d -graph $\mathcal{G} = (V; E_1, \dots, E_d)$ will be called an *almost CIS- d -graph* if $\bigcap_{i=1}^d C_i = \emptyset$ for exactly one d -tuple C_1, \dots, C_d , where $C_i \subseteq V$ is an inclusion maximal vertex-set containing no edges of color i , that is, for each $i \in [d] = \{1, \dots, d\}$, we have $(v, v') \in E_i$ for no $v, v' \in C_i$,

Notice that, by definition, the families of CIS- and almost CIS- d -graphs are disjoint.

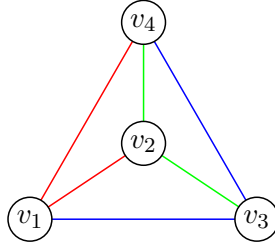
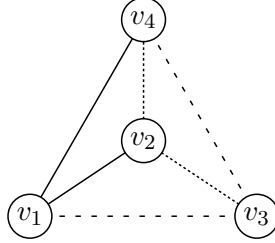
Figure 18: Almost CIS-3-graph Δ' .Figure 19: Almost CIS-3-graph Δ' (in black and white for printing).

For $d = 2$ we return to the definition of almost CIS-graphs. More precisely, an almost CIS-2-graph is a pair of two complementary almost CIS-graphs.

By Proposition 2, any split graph is either a CIS- or almost CIS-graph. Moreover, we conjecture that, except split graphs, there are no other almost CIS-graphs. The latter are in a natural one-to-one correspondence with the split almost CIS-2-graphs. Let us recall that we may have $d \geq 2$ for a 2-graph. In particular, for an arbitrary $d \geq 2$ and almost CIS graph $G = (V, E)$ let us define a d -graph $\mathcal{G} = (V; E_1, \dots, E_d)$ by setting $E_1 = E$, $E_2 = \overline{E}$, and $E_i = \emptyset$ for each $i > 2$. It is easy to see that \mathcal{G} is an almost CIS- d -graph.

Let us note that already the 3-graph Δ is not almost CIS, since it has two distinct triplets $C_1 = \{v_2, v_3\}$, $C_2 = \{v_3, v_1\}$, $C_3 = \{v_1, v_2\}$ and $C'_1 = \{v_3, v_1\}$, $C'_2 = \{v_1, v_2\}$, $C'_3 = \{v_2, v_3\}$ such that $C_1 \cap C_2 \cap C_3 = \emptyset$ and $C'_1 \cap C'_2 \cap C'_3 = \emptyset$; see Section 4.2 for more details.

However, it is not difficult to extend Δ to an almost CIS-3-graph. Indeed, let us add to Δ a new vertex v_4 such that $(v_1, v_4) \in E_1$, $(v_2, v_4) \in E_2$, $(v_3, v_4) \in E_3$, and denote the obtained 3-graph by Δ' . In other words, $\Delta' = (V; E_1, E_2, E_3)$, where

$$V = \{v_1, v_2, v_3, v_4\}; E_1 = \{(v_1, v_2), (v_1, v_4)\}, E_2 = \{(v_2, v_3), (v_2, v_4)\}, E_3 = \{(v_3, v_1), (v_3, v_4)\}. \quad (1.2)$$

It is easy to see that in Δ' vertices v_1, v_2, v_3 induce Δ and that

$$\mathcal{C}_1 = \{(v_3, v_1), (v_2, v_3, v_4)\}, \mathcal{C}_2 = \{(v_1, v_2), (v_3, v_1, v_4)\}, \mathcal{C}_3 = \{(v_2, v_3), (v_1, v_2, v_4)\}.$$

Thus, Δ' is an almost CIS-3-graph, since only one of its eight triplets has the empty intersection: $\{v_3, v_1\} \cap \{v_1, v_2\} \cap \{v_2, v_3\} = \emptyset$.

Remark 9. We can say that vertex v_4 settles one of the above two triplets of Δ , namely, (C_1, C_2, C_3) . However, if we introduce one more vertex v_5 to settle (C'_1, C'_2, C'_3) , too, then we have to choose a color for (v_4, v_5) . It is easy to verify that for each coloring of it a new Δ appears that should be, in its turn, settled, etc.; see Section 4.2 for more details.

Furthermore, it is not difficult to verify that Δ' is a unique almost CIS-3-graph with four vertices. Let us recall that there are also two CIS-3-graphs given in Figures 13 and 14.

Standardly, for any $d \geq 3$ we obtain an almost CIS-3-graph $\mathcal{G} = (V; E_1, \dots, E_d)$ setting E_1, E_2, E_3 , and V by (1.2) and $E_i = \emptyset$ for each $i > 3$.

Let us also remark that, unlike CIS- d -graphs, almost CIS- d -graphs (and, in particular, almost CIS-graphs) are not closed under substitution. Nevertheless, we get an almost CIS-3-graph substituting Δ' for a vertex of a 1-graph \mathcal{G} . More precisely, \mathcal{G} is a monochromatic clique whose all edges are colored by one of the three colors of Δ' .

However, if all edges of \mathcal{G} are colored by a new, fourth, color then the obtained 4-graph is not almost CIS. Similarly, we won't get an almost CIS-3- or 4-graph by substituting Δ' for more than one vertex of \mathcal{G} , nor, vice-versa, by substituting \mathcal{G} for a vertex of Δ' .

Finally, let us mention that we are not aware of any other almost CIS- d -graphs.

2 Proof of Theorem 1

In this section we prove Theorem 1 which claims that graphs satisfying condition COMB(3, 3) are CIS-graphs. First we describe the structure of our proof and a few main lemmas, then we give the complete proofs which are technical, long, and partially computer assisted.

2.1 Plan of the proof of Theorem 1

Let us assume by contradiction that there is a graph G such that

- (i) it contains no induced 3-combs and 3-anti-combs,
- (ii) each induced 2-comb is settled in G , and
- (iii) there exist a maximal clique C and a maximal stable set S in G such that $S \cap C = \emptyset$.

First, we will prove that G must contain an induced subgraph G_{10} , shown in Figure 20.

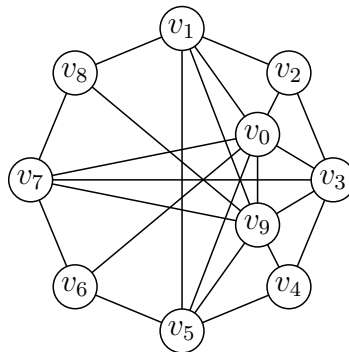

Figure 20: Graph G_{10} .

Lemma 2. *If G satisfies conditions (i), (ii), and (iii), then G must contain an induced G_{10} .*

Graph G_{10} contains no induced 3-combs and 3-anti-combs, yet it contains several unsettled induced 2-combs. To settle them we have to introduce 10 new vertices that, somewhat surprisingly, induce a graph isomorphic to G_{10} itself (since otherwise an induced 3-comb or 3-anti-comb would appear). Moreover, the obtained 20-vertex graph is the sum of two Petersen graphs, that is, the graph $2\mathcal{P}$ described in section 1.4, Figure 8.

Lemma 3. *If G contains an induced G_{10} and satisfies conditions (i) and (ii), then G must contain an induced $2\mathcal{P}$.*

Let us recall that $2\mathcal{P}$ contains 10 uncertain pairs of vertices each of which can be either an edge or non-edge. Hence in fact, $2\mathcal{P}$ represent $2^{10} = 1024$ graphs. We will show that all these 1024 graphs contain no induced 3-combs and 3-anti-combs and, moreover, each induced 2-comb in $2\mathcal{P}$ (that contains no uncertain pair) is settled. However, 36 induced 2-combs appear in $2\mathcal{P}$ whenever we fix any uncertain pair either as an edge or as a non-edge. It is easy to see that none of these 2-combs are settled in $2\mathcal{P}$. We will show that they cannot be settled in G either, because if a vertex of G were settling one of them then an induced 3-comb or 3-anti-comb would exist in G . We can reformulate this result as follows.

Lemma 4. *If G satisfies conditions (i) and (ii), then it cannot contain an induced $2\mathcal{P}$.*

Obviously, the above 3 lemmas prove Theorem 1 by contradiction. We will prove Lemmas 2, 3, and 4 below in Sections 2.2, 2.3, and 2.4, respectively.

The last two proofs are computer assisted. We use two procedures, one for generating all induced 2-combs, 3-combs, and 3-anti-combs of a given graph G , and a second one for testing if all induced 2-combs are settled in G , and outputting all non-settled ones.

2.2 Proof of Lemma 2

Let us consider a pair of disjoint maximal clique C and maximal stable set S of G , as in condition (iii). Let $N_S(v)$ be the set of neighbors of v in S . Notice that

$$\bigcap_{v \in C} N_S(v) = \emptyset, \quad (2.3)$$

because C is maximal. Moreover,

$$N_S(v) \neq \emptyset \quad \text{for all } v \in C, \quad (2.4)$$

because S is maximal.

We assume that G satisfies conditions (i), (ii), and (iii). The following series of claims will imply the lemma.

Claim 4.1. *Given a maximal clique C and a (not necessarily maximal) stable set S in G such that $C \cap S = \emptyset$, there exists vertices $u, v \in C$ such that $N_S(u) \cap N_S(v) = \emptyset$.*

Proof. Assume by contradiction that for all pairs of vertices $u, v \in C$, we have $N_S(u) \cap N_S(v) \neq \emptyset$. By this assumption, $|C| \geq 3$, otherwise C would not be maximal.

So let $I = \{v_1, v_2, \dots, v_k\}$ be a minimal subset of C such that $\bigcap_{v \in I} N_S(v) = \emptyset$. Such a minimal subset of C exists according to (2.3). Furthermore, by our assumption $|I| \geq 3$.

Now, define $u_i \in \bigcap_{j \neq i} N_S(v_j)$ for $i = 1, \dots, k$. Note that $u_i \neq u_j$, due to the minimality of I . Thus, any 3 vertices $v_1, v_2, v_3 \in I$ with the corresponding u_1, u_2, u_3 form an \overline{S}_3 (see Figure 21), contradicting condition (i). \square

Note that for this claim we only need that G is S_3 -free.

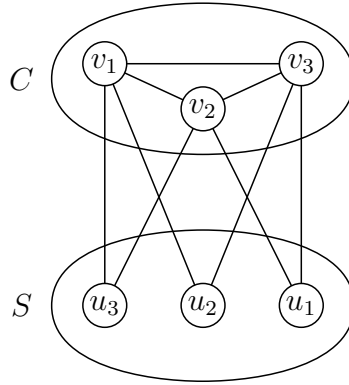

Figure 21: Illustration of the proof of Claim 4.1.

From Claim 4.1, it follows that there are some pairs of vertices $u, v \in C$ such that $N_S(u) \cap N_S(v) = \emptyset$. Hence, there exist $x \in N_S(u)$ and $y \in (N_S(v))$ such that x, u, v, y form an S_2 not settled by any vertex of S . The following claim states a useful property of any vertex $w \in V(G)$ settling such an S_2 .

Claim 4.2. *We have $N_S(w) \subseteq N_S(u) \cup N_S(v)$.*

Proof. First notice that $x, y \notin N_S(w)$ because w is a settling vertex. Then, assume by contradiction that there is a vertex $z \in N_S(w) \setminus (N_S(u) \cup N_S(v))$. Then, vertices u, v, w, x, y, z form an S_3 (see Figure 22), contradicting condition (i). \square

For the remainder of the proof we fix a maximal clique C , a maximal stable set S , and vertices $u, v \in C$ such that

- (iv) $C \cap S = \emptyset$, $N_S(u) \cap N_S(v) = \emptyset$, and $N_S(u) \cup N_S(v)$ is minimal,

among all possible choices of such sets C, S and vertices $u, v \in C$ satisfying the conditions of (iv). Let us note that by (2.3) and (2.4), we have such a selection of C, S, u , and v for which $N_S(u) \neq \emptyset$, $N_S(v) \neq \emptyset$, and hence $u \neq v$.

Claim 4.3. *Let $x \in N_S(u)$, $y \in N_S(v)$, and w be a vertex of $V(G)$ that settles $S_2 = \{x, u, v, y\}$. Then, $N_S(w) \cap N_S(u) \neq \emptyset$ and $N_S(w) \cap N_S(v) \neq \emptyset$.*

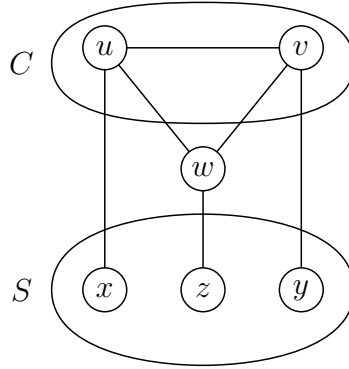

Figure 22: Illustration of the proof of Claim 4.2.

Proof. From Claim 4.2, we know that $N_S(w) \subseteq N_S(u) \cup N_S(v)$. Assume by contradiction that e.g., $N_S(w) \cap N_S(u) = \emptyset$. This implies that $N_S(w) \subseteq N_S(v) \setminus \{y\}$ (since w is settling S_2).

Then, consider a maximal clique $C' \supseteq \{u, w\}$. Notice that $C' \cap S = \emptyset$ because $N_S(w) \cap N_S(u) = \emptyset$. But $N_S(u) \cup N_S(w) \subsetneq N_S(u) \cup N_S(v)$, since $y \notin N_S(u) \cup N_S(w)$, contradicting property (iv), that is, the minimality of $N_S(u) \cup N_S(v)$. \square

We define next a minimal collection of settling vertices \mathcal{W} . Given a maximal clique C , a maximal stable set S , and vertices $u, v \in C$ satisfying property (iv), let us consider all possible 2-combs induced by $\{x, u, v, y\}$ in G , where $x \in N_S(u)$ and $y \in N_S(v)$. Let us call a *settling vertex* a vertex w of G that settles such a 2-comb. If w is a settling vertex, then we have by Claims 4.2 and 4.3 that $X(w) = N_S(w) \cap N_S(u)$ and $Y(w) = N_S(w) \cap N_S(v)$ are subsets, uniquely defined by w , satisfying the following properties:

$$X(w) \neq \emptyset \quad Y(w) \neq \emptyset \quad \text{and} \quad N_S(w) = X(w) \cup Y(w). \quad (2.5)$$

Note that we may have $X(w) = X(w')$ and $Y(w) = Y(w')$ for two distinct settling vertices. Note further that if $X(w) \subseteq X(w')$ and $Y(w) \subseteq Y(w')$ hold for two vertices w and w' , then the set of S_2 subgraphs settled by w' are also settled by w .

Let us consider now all pairs of subsets (X, Y) such that $X = X(w)$ and $Y = Y(w)$ for some settling vertex w . Let us call such a pair (X, Y) *minimal*, if for there is no settling vertex w' such that $X(w') \subseteq X$, $Y(w') \subseteq Y$ and $X(w') \cup Y(w') \subsetneq X \cup Y$, and let \mathcal{XY} denote the collection of all such minimal pairs. For each pair $(X, Y) \in \mathcal{XY}$ let us choose one settling vertex $w = w_{XY}$ for which $X = X(w)$ and $Y = Y(w)$, and denote by $\mathcal{W} = \{w_{XY} \mid (X, Y) \in \mathcal{XY}\}$ the collection of these vertices.

Claim 4.4. *There are at least two distinct vertices in \mathcal{W} .*

Proof. The statement follows from the definition of \mathcal{W} and (2.5). Indeed, if $w_{XY} \in \mathcal{W}$, then by (2.5) there are vertices $x \in X$ and $y \in Y$, and hence the 2-comb S_2 induced by

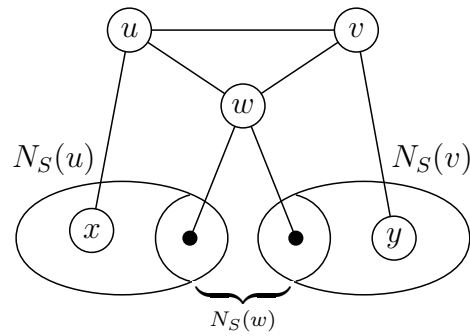

Figure 23

$\{x, u, v, y\}$ is not settled by w_{XY} . Let w be a vertex settling this 2-comb. By the minimality of (X, Y) the pair $(X(w), Y(w))$ is not comparable to (X, Y) , and hence we must have a pair $(X', Y') \in \mathcal{X}\mathcal{Y}$ such that $X' \subseteq X$ and $Y' \subseteq Y$. Consequently, $w_{X'Y'} \in \mathcal{W}$ and $w_{XY} \neq w_{X'Y'}$. \square

In the sequel we consider pairs of vertices from \mathcal{W} and derive some containment relations for the corresponding sets. First we consider pairs which are edges of G .

Claim 4.5. *If $(w_{XY}, w_{X'Y'}) \in E(G)$ and $X \cap X' \neq \emptyset$, then $Y \subseteq Y'$ or $Y' \subseteq Y$.*

Proof. Assume by contradiction that there is a vertex $x \in X \cap X'$, but $Y \not\subseteq Y'$ and $Y' \not\subseteq Y$, that is, there are vertices $y_1 \in Y \setminus Y'$ and $y_2 \in Y' \setminus Y$. Then, an \overline{S}_3 is formed by $w_{XY}, w_{X'Y'}, v, x, y_1, y_2$ (see Figure 24), in contradiction to (i). \square

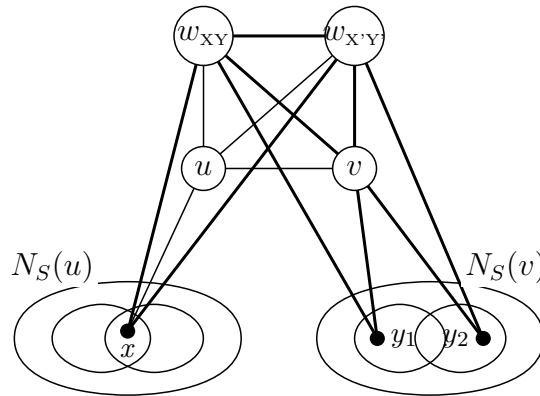

Figure 24: Illustration of the proof of Claim 4.5.

We next show a stronger version of the above claim, by proving proper containments.

Claim 4.6. *If $(w_{XY}, w_{X'Y'}) \in E(G)$ and $X \cap X' \neq \emptyset$, then either $Y \subsetneq Y'$ or $Y' \subsetneq Y$.*

Proof. Assume by contradiction that $X \cap X' \neq \emptyset$ and $Y = Y'$. By this assumption $Y \cap Y' \neq \emptyset$. Hence, we can apply Claim 4.5 (with the roles of X and Y exchanged), and conclude that $X \subseteq X'$ or $X' \subseteq X$.

Say e.g., that $X \subseteq X'$. Then, $X \cup Y \subseteq X' \cup Y'$, and consequently we would not have both $w_{X,Y}$ and $w_{X',Y'}$ in \mathcal{W} , by its definitions. □

Claim 4.7. *If $(w_{XY}, w_{X'Y'}) \in E(G)$, then exactly one of the following holds:*

- (a) $X \cap X' = Y \cap Y' = \emptyset$,
- (b) $(X \subsetneq X' \text{ and } Y' \subsetneq Y)$,
- (c) $(X' \subsetneq X \text{ and } Y \subsetneq Y')$.

Proof. This follows from Claim 4.6 by applying it twice: once directly and once exchanging the roles of X and Y . Since X, Y, X' and Y' are nonempty sets by (2.5), cases (a), (b) and (c) are pairwise exclusive. □

Next we consider pairs of settling vertices that are not edges of G .

Claim 4.8. *If $(w_{XY}, w_{X'Y'}) \notin E(G)$, then either $X \subseteq X'$ or $Y \subseteq Y'$.*

Proof. If not, then there are vertices $x \in X \setminus X'$ and $y \in Y \setminus Y'$ such that $\{w_{XY}, u, v, x, y, w_{X'Y'}\}$ form a 3-anti-comb \overline{S}_3 (see Figure 25), in contradiction to condition (i).

Note that we cannot have both containments in the claim, because of the minimality of pairs in \mathcal{XY} . □

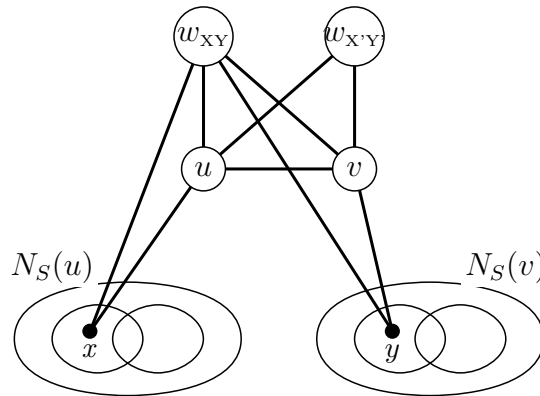

Figure 25: Illustration of the 3-anti-comb \overline{S}_3 induced by $\{w_{XY}, u, v, x, y, w_{X'Y'}\}$.

Claim 4.9. *If $(w_{XY}, w_{X'Y'}) \notin E(G)$, then exactly one of the following must hold:*

- (a) $X \subsetneq X'$ and $Y' \subsetneq Y$,
- (b) $X' \subsetneq X$ and $Y \subsetneq Y'$,
- (c) $X = X'$,
- (d) $Y = Y'$.

Proof. Since the roles of (X, Y) and (X', Y') are symmetric, it follows directly by Claim 4.8 that one of (a), (b), (c), or (d) holds. To see that exactly one of them holds, it is enough to note that (c) and (d) together would contradict the minimality of the pairs $(X, Y) \in \mathcal{XY}$. \square

We are going to show next that if (c) or (d) holds in the previous claim for some vertices $w_{XY}, w_{X'Y'} \in \mathcal{W}$, then G contains an induced G_{10} , as claimed in Lemma 2. For this end, let us first observe that if e.g., (d) holds, then we cannot have $X \subseteq X'$ or $X' \subseteq X$, by the minimality and uniqueness of pairs in \mathcal{XY} . Consequently, we can choose vertices $x \in X \setminus X'$, and $x' \in X' \setminus X$. Let us also choose an arbitrary vertex $y \in Y = Y'$ (which exists by (2.5)), and consider first the 2-comb S_2 induced by $\{x, u, v, y\}$. This 2-comb is settled by neither w_{XY} nor $w_{X'Y'}$, and therefore there must be a vertex $w_{AB} \in \mathcal{W}$ settling it, since all 2-combs, containing (u, v) as their middle edge, are settled by some vertices in \mathcal{W} .

Claim 4.10. *If $Y = Y'$, then $(w_{AB}, w_{XY}) \in E(G)$.*

Proof. Since $x \notin A$ and $y \notin B$ we have

$$X \not\subseteq A \quad \text{and} \quad Y \not\subseteq B \tag{2.6}$$

implied. Assume indirectly that $(w_{AB}, w_{XY}) \notin E(G)$, then the previous observation implies that in Claim 4.9 applied to w_{XY} and w_{AB} none of (a), (b), (c) or (d) could hold. This contradiction proves the claim. \square

Claim 4.11. *If $Y = Y'$, then $A \cap X = B \cap Y = \emptyset$, $A \cup X = N_S(u)$ and $B \cup Y = N_S(v)$.*

Proof. Due to (2.6) only (a) of Claim 4.7 is possible, that is $A \cap X = B \cap Y = \emptyset$ is implied. Therefore the neighborhoods of w_{AB} and w_{XY} within S are disjoint, and since they are subsets of the neighborhoods of u and v , they cannot be proper subsets by property (iv), implying the statement. \square

Claim 4.12. *If $Y = Y'$, then $(w_{AB}, w_{X'Y'}) \notin E(G)$.*

Proof. Since $y \in Y' \setminus B$ and $x \in X \setminus A$ (since w_{AB} is settling $\{x, u, v, y\}$), cases (b) and (c) of Claim 4.7 cannot hold for the pair w_{AB} and $w_{X'Y'}$. Thus, if $(w_{AB}, w_{X'Y'}) \in E(G)$ then $A \cap X' = B \cap Y' = \emptyset$ would follow by Claim 4.7. Therefore, the neighborhoods of w_{AB} and $w_{X'Y'}$ in S are disjoint, and their union is a proper subset of $N_S(u) \cup N_S(v)$, in contradiction with property (iv). This contradiction proves the claim. \square

Claim 4.13. *If $Y = Y'$, then $A = X' = N_S(u) \setminus X$ and $Y = Y' = N_S(v) \setminus B$.*

Proof. Claim 4.11 and Claim 4.9 applied to w_{AB} and $w_{X'Y'}$ implies that only (c) of Claim 4.9 can hold. Thus, the statement implied by Claim 4.11 and (c) of Claim 4.9. \square

Let us still assume $Y = Y'$ and consider next the 2-comb induced by $\{x', u, v, y\}$ (where $x' \in X' \setminus X$). None of the vertices w_{XY} , $w_{X'Y'}$ and w_{AB} settle this 2-comb, hence, there is a vertex $w_{A'B'} \in \mathcal{W}$ that settles it. By exchanging the roles of w_{XY} and $w_{X'Y'}$ in Claims 4.10 - 4.13, we can conclude that

$$(w_{A'B'}, w_{XY}) \notin E(G), \quad (w_{A'B'}, w_{X'Y'}) \in E(G), \quad A' = X' \quad \text{and} \quad B = B'. \quad (2.7)$$

Claim 4.14. *If $Y = Y'$ or $X = X'$, then G contains an induced G_{10} .*

Proof. Note that the roles of conditions (c) and (d) in Claim 4.9 are perfectly symmetric, thus we could arrive to the same conclusions from both assumptions. Starting with $Y = Y'$ we arrived to the equalities of Claim 4.13 and (2.7). Choosing one vertex from each of the sets X , Y , A , and B , these four vertices together with u , v , w_{XY} , $w_{X'Y'}$, w_{AB} , and $w_{A'B'}$ form an induced G_{10} by the above claims and definitions (see Figure 26). \square

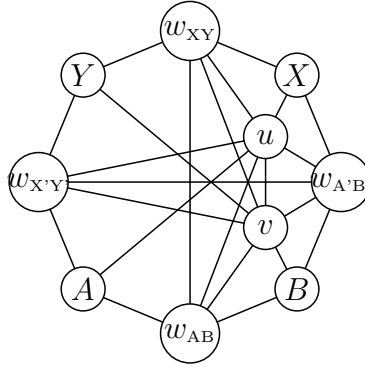

Figure 26: Illustration of the induced G_{10} that appears by adding the settling vertices w_{XY} , $w_{X'Y'}$, w_{AB} , $w_{A'B'}$.

For the rest of the proof, we assume that (a) or (b) of Claim 4.9 holds for every non-edge $(w_{XY}, w_{X'Y'}) \notin E(G)$. We are going to derive a contradiction from this assumption, completing the proof of Lemma 2.

First, we show that under the above assumption, case (a) of Claim 4.7 never holds.

Claim 4.15. *If $(w_{XY}, w_{X'Y'}) \in E(G)$, then either $X \cap X' \neq \emptyset$ or $Y \cap Y' \neq \emptyset$.*

Proof. Assume by contradiction that (a) of Claim 4.9 holds, that is that $X \cap X' = Y \cap Y' = \emptyset$. Then, by the minimality of $N_S(u) \cup N_S(v)$ as stated in property (iv), and by Claim 4.2, we know that $N_S(u) = X \cup X'$ and $N_S(v) = Y \cup Y'$.

Let us consider vertices $x \in X$ and $y \in Y'$ such that the set $\{x, u, v, y\}$ forms a 2-comb. This 2-comb is settled neither by w_{XY} nor by $w_{X'Y'}$. Since every 2-comb with (u, v) as a middle edge is settled by a vertex of \mathcal{W} , this 2-comb is also settled by one, say by a vertex $w_{AB} \in \mathcal{W}$. Let us now check the connections of this vertex to w_{XY} and $w_{X'Y'}$. We consider two cases:

Case 1. If $(w_{AB}, w_{XY}) \notin E(G)$, then by Claim 4.9 we must have $A \subset X$ and $Y \subset B$, because $x \notin A$, and because we assumed that only cases (a) or (b) are possible in Claim 4.9.

If $(w_{AB}, w_{X'Y'}) \notin E(G)$, then by similar reasoning based on by Claim 4.9 and the fact that $y \notin B$ we can conclude that $X' \subset A$ and $B \subset Y'$. This however leads to a contradiction, since $A \subseteq X$ and $X \cap X' = \emptyset$.

Hence, we must have $(w_{AB}, w_{X'Y'}) \in E(G)$ in this case. Then by Claim 4.7 either $X' \cap A = Y' \cap B = \emptyset$ or A, X' and B, Y' are inversely nested. However, the latter is not possible, since $A \subset X$ and $X \cap X' = \emptyset$. In this case the neighborhoods of w_{AB} and $w_{X'Y'}$ are disjoint in S , and their union is a proper subset of $N_S(u) \cup N_S(v)$ (since $x \notin A$), in contradiction with property (iv).

Case 2. If $(w_{AB}, w_{XY}) \in E(G)$, then (b) of Claim 4.7 is not possible, since $x \in X \setminus A$. If (a) holds, that is if $X \cap A = Y \cap B = \emptyset$, then the neighborhoods of w_{AB} and w_{XY} are disjoint in S , and their union is a proper subset of $N_S(u) \cup N_S(v)$ (since $y \in Y' \setminus B$), contradicting to property (iv). Consequently, case (c) holds, that is $A \subset X$ and $Y \subset B$, and consequently we can proceed as in Case 1.

In both cases we arrived to a contradiction, completing the proof of the claim. □

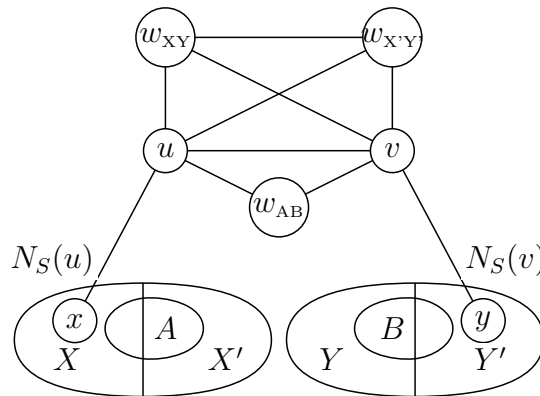

Figure 27

The above claim implies that if $(w_{XY}, w_{X'Y'}) \in E(G)$, then the sets X, X' and Y, Y' are inversely nested (cases (b) or (c) in Claim 4.7). Since we also assumed that only cases (a) or (b) are possible in Claim 4.9, we can conclude that for all pairs of settling vertices $w_{XY}, w_{X'Y'} \in \mathcal{W}$ we have

$$\text{either } X \subset X' \text{ and } Y' \subset X \quad \text{or} \quad X' \subset X \text{ and } Y \subset Y'. \tag{2.8}$$

Now we are ready to complete the proof of the lemma.

Let us consider an arbitrary vertex $w_{XY} \in \mathcal{W}$. Since w_{XY} is settling a 2-comb with (u, v) as its middle edge, we must have $Y \neq N_S(v)$, and consequently we can choose a vertex

$y \in N_S(v) \setminus Y$. Furthermore, we have $X \neq \emptyset$ by (2.5), thus we can also choose a vertex $x \in X$.

Then, the 2-comb S_2 induced by $\{x, u, v, y\}$ is not settled by w_{XY} , and therefore there is a vertex $w_{X'Y'} \in \mathcal{W}$ settling this 2-comb. Then, by (2.8) we must have $X' \subseteq X \setminus \{x\}$ and $Y \subset Y'$, since $x \notin X'$.

Then, $X' \neq \emptyset$ by (2.5), so we can choose a vertex $x' \in X' \subsetneq X$. The 2-comb induced by $\{x', u, v, y\}$ is not settled by either w_{XY} or $w_{X'Y'}$, and therefore there is a vertex $w_{X''Y''} \in \mathcal{W}$ settling this 2-comb.

Clearly, we can repeat the same arguments, and choose a vertex $x'' \in X'' \subsetneq X' \subsetneq X$, etc., resulting in an infinite chain $X \supsetneq X' \supsetneq X'' \supsetneq \dots$ of strictly nested nonempty subsets, contradicting the finiteness of G . This concludes the proof of the lemma. \square

2.3 Proof of Lemma 3

In this section we present the proof of Lemma 3, claiming that if G contains G_{10} as an induced subgraph and satisfies conditions (i) and (ii) of Section 2.1, then it must have an induced $2\mathcal{P}$ configuration (see Figures 20 and 8).

The proof is a case analysis that was assisted by a computer program. We assume by contradiction that there is a graph that has an induced G_{10} , has all 2-combs settled and does not contain 3-combs and 3-anti-combs. The graph G_{10} itself contains neither 3-combs nor 3-anti-combs, but it has several 2-combs that are not settled in it. For instance, such 2-combs are induced by $\{v_2, v_1, v_5, v_4\}$, $\{v_6, v_7, v_3, v_4\}$, $\{v_1, v_2, v_3, v_7\}$, etc. Therefore, some other vertices of G must settle these 2-combs.

We show that in order to settle all 2-combs of G_{10} , the graph G must contain a disjoint copy of G_{10} such that the 20 vertices of these two G_{10} subgraphs form an induced $2\mathcal{P}$ configuration. Since we do not know G , we try to extend G_{10} , and we show that this can be done essentially in a unique way.

We use a computer program to find all unsettled 2-combs of G_{10} . For each, one by one, we introduce a new vertex to settle it. After adding a settling vertex $v' \notin V(G_{10})$, we consider the pairs (v', v_j) for all $v_j \in V(G_{10})$. Some of these pairs are forced to be edges or non-edges, since G contains no induced 3-combs and 3-anti-combs. Some other pairs, however, may remain *uncertain*, that is those pairs may be either edges or non-edges of G . Surprisingly, all but one of the pairs are forced. We can discover the forced edge assignments by excluding all other possible assignments. This can be accomplished by exhibiting an induced 3-comb or 3-anti-comb. This task is also assisted by a computer program.

Another property which simplifies our case analysis is the symmetry of G_{10} . In particular, we reduce significantly the number of cases in our proof by means of the following three automorphisms:

$$A_1: (3)(7)(1, 5)(2, 4)(6, 8)(0, 9)$$

$$A_2: (1)(5)(2, 8)(3, 7)(4, 6)(0, 9)$$

$A_3: (7, 5, 3, 1)(8, 6, 4, 2)(0, 9)$

They are given in the *cycle* notation, that is (i_1, i_2, \dots, i_n) means the cyclic mapping $i_1 \mapsto i_2, i_2 \mapsto i_3, \dots, i_n \mapsto i_1$. Figure 28 shows the graphs after the application of these automorphisms.

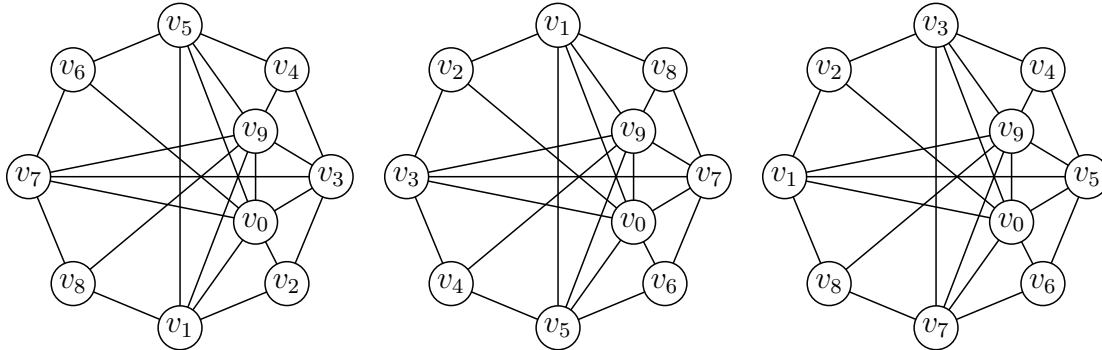

Figure 28: Graphs $A_1(G_{10}), A_2(G_{10}),$ and $A_3(G_{10})$.

From now on we will choose some of the unsettled 2-combs to be settled, and try to fix as many edges and non-edges as possible. Even though the order that we pick the 2-combs may seem arbitrary, we follow an order that reduces the number of cases to be considered.

Let us choose first the 2-comb induced by $\{v_2, v_3, v_7, v_8\}$, and denote by v'_1 the vertex that settles it. The pairs (v'_1, v_3) and (v'_1, v_7) are forced to be edges, while (v'_1, v_2) and (v'_1, v_8) are forced to be non-edges, by the definition of settling. There are six more pairs, connecting v'_1 with v_0, v_1, v_4, v_5, v_6 and v_9 , that remain uncertain.

Let us note first that (v'_1, v_5) has to be a non-edge, since otherwise the vertices $\{v_3, v_7, v'_1, v_2, v_8, v_5\}$ form a 3-comb. Unlike (v'_1, v_5) , the pairs $(v'_1, v_0), (v'_1, v_4), (v'_1, v_6), (v'_1, v_9)$ cannot be fixed if treated individually. But analyzing them together, we conclude that (v'_1, v_4) and (v'_1, v_6) are edges, while (v'_1, v_0) and (v'_1, v_9) are non-edges. Table 1 shows that in any other case there is an induced 3-comb or 3-anti-comb.

Only one pair (v'_1, v_1) remains uncertain, since no induced S_3 nor $\overline{S_3}$ appears whether this pair is an edge or not.

Table 2 shows the connections between v'_1 and the vertices of G_{10} .

Next, we use automorphisms to simplify case analysis for the three 2-combs induced by $\{v_4, v_3, v_7, v_6\}$, $\{v_6, v_5, v_1, v_8\}$, and $\{v_2, v_1, v_5, v_4\}$ respectively, and not settled by v'_1 .

Let us denote by v'_5 the vertex that settles $\{v_4, v_3, v_7, v_6\}$. By applying the automorphism A_1 to G_{10} , the 2-comb $\{v_2, v_3, v_7, v_8\}$ settled by v'_1 becomes $\{v_4, v_3, v_7, v_6\}$. Consequently, v'_5 should have the same connections as v'_1 has after applying A_1 . Table 3 shows the connections between v'_5 and G_{10} .

Analogously, let us denote by v'_3 the vertex that settles $\{v_2, v_1, v_5, v_4\}$. By applying A_3 to G_{10} , $\{v_2, v_3, v_7, v_8\}$ becomes $\{v_2, v_1, v_5, v_4\}$. Therefore, v'_3 should have the same connections as v'_1 after transformation A_3 . Table 4 shows the connections between v'_3 and G_{10} .

Next, let us denote by v'_7 the vertex that settles $\{v_8, v_1, v_5, v_6\}$. By applying A_3 then A_2 to G_{10} , $\{v_2, v_3, v_7, v_8\}$ becomes $\{v_8, v_1, v_5, v_6\}$. Thus, v'_7 should have the same connections as

| (v'_1, v_4) | (v'_1, v_6) | (v'_1, v_0) | (v'_1, v_9) | S_3 or $\overline{S_3}$ |
|---------------|---------------|---------------|---------------|--|
| 0 | 0 | 0 | 0 | $S_3 : \{v_3, v_0, v_9, v'_1, v_6, v_8\}$ |
| 0 | 0 | 0 | 1 | $\overline{S_3} : \{v_2, v_5, v'_1, v_3, v_0, v_9\}$ |
| 0 | 0 | 1 | 0 | $\overline{S_3} : \{v_4, v_8, v'_1, v_3, v_7, v_9\}$ |
| 0 | 0 | 1 | 1 | $\overline{S_3} : \{v_4, v_6, v'_1, v_5, v_0, v_9\}$ |
| 0 | 1 | 0 | 0 | $S_3 : \{v_5, v_6, v_0, v_2, v_4, v'_1\}$ |
| 0 | 1 | 0 | 1 | $S_3 : \{v_3, v_9, v'_1, v_2, v_6, v_8\}$ |
| 0 | 1 | 1 | 0 | $\overline{S_3} : \{v_4, v_8, v'_1, v_3, v_7, v_9\}$ |
| 0 | 1 | 1 | 1 | $S_3 : \{v_3, v_9, v'_1, v_2, v_6, v_8\}$ |
| 1 | 0 | 0 | 0 | $S_3 : \{v_3, v_0, v_9, v_6, v_8, v'_1\}$ |
| 1 | 0 | 0 | 1 | $\overline{S_3} : \{v_2, v_5, v'_1, v_3, v_0, v_9\}$ |
| 1 | 0 | 1 | 0 | $S_3 : \{v_4, v_5, v_9, v_6, v_8, v'_1\}$ |
| 1 | 0 | 1 | 1 | $S_3 : \{v_7, v_0, v'_1, v_2, v_4, v_8\}$ |
| 1 | 1 | 0 | 0 | none |
| 1 | 1 | 0 | 1 | $S_3 : \{v_3, v_9, v'_1, v_2, v_6, v_8\}$ |
| 1 | 1 | 1 | 0 | $S_3 : \{v_7, v_0, v'_1, v_2, v_4, v_8\}$ |
| 1 | 1 | 1 | 1 | $S_3 : \{v_3, v_9, v'_1, v_2, v_6, v_8\}$ |

Table 1: Case analysis for the pairs (v'_1, v_0) , (v'_1, v_4) , (v'_1, v_6) , (v'_1, v_9) .

| | v_1 | v_2 | v_3 | v_4 | v_5 | v_6 | v_7 | v_8 | v_9 | v_0 |
|--------|-------|-------|-------|-------|-------|-------|-------|-------|-------|-------|
| v'_1 | * | 0 | 1 | 1 | 0 | 1 | 1 | 0 | 0 | 0 |

Table 2: Connections between v'_1 and G_{10} . An entry 1 for v_i means that there is an edge between v'_1 and v_i , while 0 means that there is no edge between them. Finally, * means an uncertain pair.

v'_1 after transformations A_3 then A_2 (or the same connections as v'_3 after A_2). Table 5 shows the connections between v'_7 and G_{10} .

Let us next consider four 2-combs induced by $\{v_5, v_1, v_2, v_3\}$, $\{v_1, v_5, v_4, v_3\}$, $\{v_7, v_3, v_4, v_5\}$, and $\{v_1, v_2, v_3, v_7\}$. They are not settled by any of the vertices of G_{10} , nor by v'_1, v'_3, v'_5, v'_7 .

Let v'_2 denote the vertex settling $\{v_3, v_4, v_5, v_1\}$. By definition of settling, the pairs (v'_2, v_4) and (v'_2, v_5) are edges, while (v'_2, v_1) and (v'_2, v_3) are non-edges. The pair (v'_2, v_9) must be an edge, since otherwise $\{v_1, v_3, v'_2, v_4, v_5, v_9\}$ forms a 3-anti-comb. Table 6 shows the case analysis for the pairs (v'_2, v_6) , (v'_2, v_7) , (v'_2, v_8) , and (v'_2, v_0) . The only possible configuration is that (v'_2, v_6) , (v'_2, v_7) , (v'_2, v_8) are edges, and (v'_2, v_0) is not. The pair (v'_2, v_2) remains uncertain. Table 7 shows the connections between v'_2 and the vertices of G_{10} .

| | v_1 | v_2 | v_3 | v_4 | v_5 | v_6 | v_7 | v_8 | v_9 | v_0 |
|--------|-------|-------|-------|-------|-------|-------|-------|-------|-------|-------|
| v'_5 | 0 | 1 | 1 | 0 | * | 0 | 1 | 1 | 0 | 0 |

Table 3: Connections between v'_5 and G_{10} .

| | v_1 | v_2 | v_3 | v_4 | v_5 | v_6 | v_7 | v_8 | v_9 | v_0 |
|--------|-------|-------|-------|-------|-------|-------|-------|-------|-------|-------|
| v'_3 | 1 | 0 | * | 0 | 1 | 1 | 0 | 1 | 0 | 0 |

Table 4: Connections between v'_3 and G_{10} .

| | v_1 | v_2 | v_3 | v_4 | v_5 | v_6 | v_7 | v_8 | v_9 | v_0 |
|--------|-------|-------|-------|-------|-------|-------|-------|-------|-------|-------|
| v'_7 | 1 | 1 | 0 | 1 | 1 | 0 | * | 0 | 0 | 0 |

Table 5: Connections between v'_7 and G_{10} .

Let v'_4 denote the vertex settling $\{v_5, v_1, v_2, v_3\}$. By applying A_1 to G_{10} , the subgraph $\{v_1, v_5, v_4, v_3\}$ becomes $\{v_5, v_1, v_2, v_3\}$. Therefore, vertex v'_4 must have the same connections as v'_2 after transformation A_1 . Table 8 shows the connections between v'_4 and G_{10} .

Next, let v'_6 denote the vertex settling $\{v_7, v_3, v_4, v_5\}$. By applying transformations, first A_1 and then A_3 , to G_{10} , the subgraph $\{v_1, v_5, v_4, v_3\}$ becomes $\{v_7, v_3, v_4, v_5\}$. Thus, v'_6 must have the same connections as v'_2 after the transformation $A_3 \circ A_1$. Table 9 shows the connections between v'_6 and G_{10} .

Let us next denote by v'_8 the vertex that settles $\{v_1, v_2, v_3, v_7\}$. By applying A_3^{-1} , to G_{10} , the subgraph $\{v_1, v_5, v_4, v_3\}$ becomes $\{v_1, v_2, v_3, v_7\}$. Therefore, v'_8 should have the same connections as v'_2 after A_3^{-1} . Table 10 shows the connections between v'_8 and G_{10} .

At this point, all S_2 subgraphs of G_{10} are settled by some of the vertices v'_1, v'_2, \dots, v'_8 . Yet, nothing was said about the connections between those vertices. Nevertheless, all 3-combs and 3-anti-combs that appeared to indicate contradictions were independent from those connections; in other words, each of those subgraphs contains only one vertex v'_i and the remaining five vertices are in G_{10} .

Interestingly, the connections between these eight vertices are uniquely implied. Table 11 shows the only possible assignments of edges and non-edges between the vertices v'_i and v'_j , for $i, j = 1, \dots, 8, i \neq j$. Each entry of the table contains the assignment, and the corresponding 3-comb or 3-anti-comb that would appear if the entry was reversed.

Let us notice that the pairs (v_i, v'_i) still remain uncertain. This means that all 2^8 possible graphs have no induced 3-combs and 3-anti-combs. Yet, they contain some unsettled induced 2-combs.

Next, we introduce the automorphism A_4 of the current configuration, induced by the 18 vertices $V(G_{10}) \cup \{v'_1, \dots, v'_8\}$.

$$A_4: (1, 3, 5, 7)(2, 4, 6, 8)(0, 9)(1', 3', 5', 7')(2', 4', 6', 8').$$

Let us further consider the unsettled 2-comb induced by $\{v_2, v'_1, v'_5, v_6\}$, and denote by v'_0 the vertex that settles it. By definition, (v'_0, v'_1) and (v'_0, v'_5) are edges, while (v'_0, v_2) and (v'_0, v_6) are non-edges. The pair (v'_0, v_9) cannot be an edge, since otherwise $\{v'_1, v'_5, v'_0, v_2, v_6, v_9\}$ forms a 3-comb. Table 16 shows that (v'_0, v_4) and (v'_0, v_8) must be edges, while (v'_0, v_1) ,

| (v'_2, v_6) | (v'_2, v_7) | (v'_2, v_8) | (v'_2, v_0) | S_3 or $\overline{S_3}$ |
|---------------|---------------|---------------|---------------|--|
| 0 | 0 | 0 | 0 | $S_3 : \{v_1, v_5, v_0, v_3, v_8, v'_2\}$ |
| 0 | 0 | 0 | 1 | $\overline{S_3} : \{v_6, v_8, v'_2, v_7, v_0, v_9\}$ |
| 0 | 0 | 1 | 0 | $S_3 : \{v_4, v_5, v'_2, v_3, v_6, v_8\}$ |
| 0 | 0 | 1 | 1 | $S_3 : \{v_4, v_5, v'_2, v_3, v_6, v_8\}$ |
| 0 | 1 | 0 | 0 | $S_3 : \{v_1, v_5, v_0, v_3, v_8, v'_2\}$ |
| 0 | 1 | 0 | 1 | $\overline{S_3} : \{v_1, v_4, v_7, v_5, v_0, v'_2\}$ |
| 0 | 1 | 1 | 0 | $S_3 : \{v_4, v_5, v'_2, v_3, v_6, v_8\}$ |
| 0 | 1 | 1 | 1 | $S_3 : \{v_4, v_5, v'_2, v_3, v_6, v_8\}$ |
| 1 | 0 | 0 | 0 | $S_3 : \{v_1, v_5, v_0, v_3, v_8, v'_2\}$ |
| 1 | 0 | 0 | 1 | $\overline{S_3} : \{v_1, v_4, v_6, v_0, v_9, v'_2\}$ |
| 1 | 0 | 1 | 0 | $\overline{S_3} : \{v_1, v_7, v'_2, v_5, v_6, v_0\}$ |
| 1 | 0 | 1 | 1 | $\overline{S_3} : \{v_1, v_4, v_6, v_0, v_9, v'_2\}$ |
| 1 | 1 | 0 | 0 | $S_3 : \{v_1, v_5, v_0, v_3, v_8, v'_2\}$ |
| 1 | 1 | 0 | 1 | $\overline{S_3} : \{v_1, v_4, v_6, v_0, v_9, v'_2\}$ |
| 1 | 1 | 1 | 0 | none |
| 1 | 1 | 1 | 1 | $\overline{S_3} : \{v_1, v_4, v_6, v_0, v_9, v'_2\}$ |

Table 6: Case analysis for the pairs (v'_2, v_6) , (v'_2, v_7) , (v'_2, v_8) , (v'_2, v_0) .

| | v_1 | v_2 | v_3 | v_4 | v_5 | v_6 | v_7 | v_8 | v_9 | v_0 |
|--------|-------|-------|-------|-------|-------|-------|-------|-------|-------|-------|
| v'_2 | 0 | * | 0 | 1 | 1 | 1 | 1 | 1 | 1 | 0 |

Table 7: Connections between v'_2 and G_{10} .

(v'_0, v_3) , (v'_0, v_5) and (v'_0, v_7) , must be non-edges. Furthermore, the pairs (v'_0, v'_2) , (v'_0, v'_3) , (v'_0, v'_6) and (v'_0, v'_7) must be edges, since otherwise one of the following 3-combs would appear: $\{v_4, v_5, v'_2, v_1, v_7, v'_0\}$, $\{v_1, v_8, v'_3, v_2, v_6, v'_0\}$, $\{v_1, v_8, v'_6, v_3, v_5, v'_0\}$, or $\{v_1, v_8, v_9, v_3, v'_7, v'_0\}$. The pairs (v'_0, v'_4) and (v'_0, v'_8) cannot be edges, since otherwise the 3-combs induced by $\{v_1, v_2, v'_4, v_3, v_5, v'_0\}$ and $\{v_2, v_3, v'_8, v_1, v_7, v'_0\}$ would appear. Finally, the pair (v'_0, v_0) remains uncertain. Table 12 shows the connections between v'_0 and G_{10} .

Next, let us consider the 2-comb induced by $\{v'_3, v'_7, v_4, v_8\}$ and denote by v'_9 the vertex settling it. Notice that this 2-comb can be obtained from $\{v'_1, v'_5, v_2, v_6\}$ by applying transformation A_4 . Therefore v'_9 must have the same connections as v'_0 after applying A_4 . Table 13 shows the connections between v'_9 and G_{10} .

We summarize the connections between vertices v'_1, \dots, v'_9, v'_0 in Table 14, and between

| | v_1 | v_2 | v_3 | v_4 | v_5 | v_6 | v_7 | v_8 | v_9 | v_0 |
|--------|-------|-------|-------|-------|-------|-------|-------|-------|-------|-------|
| v'_4 | 1 | 1 | 0 | * | 0 | 1 | 1 | 1 | 0 | 1 |

Table 8: Connections between v'_4 and G_{10} .

| | | | | | | | | | | |
|--------|-------|-------|-------|-------|-------|-------|-------|-------|-------|-------|
| | v_1 | v_2 | v_3 | v_4 | v_5 | v_6 | v_7 | v_8 | v_9 | v_0 |
| v'_6 | 1 | 1 | 1 | 1 | 0 | * | 0 | 1 | 1 | 0 |

Table 9: Connections between v'_6 and G_{10} .

| | | | | | | | | | | |
|--------|-------|-------|-------|-------|-------|-------|-------|-------|-------|-------|
| | v_1 | v_2 | v_3 | v_4 | v_5 | v_6 | v_7 | v_8 | v_9 | v_0 |
| v'_8 | 0 | 1 | 1 | 1 | 1 | 1 | 0 | * | 0 | 1 |

Table 10: Connections between v'_8 and G_{10} .

| Edge | S_3 or $\overline{S_3}$ | Edge | S_3 or $\overline{S_3}$ |
|--------------------|---|--------------------|---|
| $(v'_1, v'_2) = 1$ | $S_3 : \{v_4, v_5, v'_2, v_8, v_0, v'_1\}$ | $(v'_1, v'_3) = 0$ | $\overline{S_3} : \{v_6, v'_1, v'_3, v_4, v_8, v_0\}$ |
| $(v'_1, v'_4) = 0$ | $S_3 : \{v_6, v'_1, v'_4, v_3, v_5, v_8\}$ | $(v'_1, v'_5) = 1$ | $\overline{S_3} : \{v_2, v_8, v'_1, v_3, v_7, v'_5\}$ |
| $(v'_1, v'_6) = 0$ | $S_3 : \{v_4, v'_1, v'_6, v_2, v_5, v_7\}$ | $(v'_1, v'_7) = 0$ | $S_3 : \{v_4, v'_1, v'_7, v_2, v_6, v_9\}$ |
| $(v'_1, v'_8) = 1$ | $\overline{S_3} : \{v_5, v_6, v'_8, v_2, v_9, v'_1\}$ | $(v'_2, v'_3) = 1$ | $S_3 : \{v_7, v_8, v'_2, v_4, v_0, v'_3\}$ |
| $(v'_2, v'_4) = 0$ | $\overline{S_3} : \{v_1, v_3, v'_2, v_7, v_0, v'_4\}$ | $(v'_2, v'_5) = 0$ | $S_3 : \{v_8, v'_5, v'_2, v_1, v_3, v_6\}$ |
| $(v'_2, v'_6) = 0$ | $\overline{S_3} : \{v_1, v_4, v_7, v_8, v'_2, v'_6\}$ | $(v'_2, v'_7) = 0$ | $S_3 : \{v_4, v'_7, v'_2, v_1, v_3, v_6\}$ |
| $(v'_2, v'_8) = 0$ | $\overline{S_3} : \{v_1, v_3, v'_2, v_5, v_0, v'_8\}$ | $(v'_3, v'_4) = 1$ | $S_3 : \{v_6, v_7, v'_4, v_2, v_9, v'_3\}$ |
| $(v'_3, v'_5) = 0$ | $S_3 : \{v_8, v'_5, v'_3, v_2, v_6, v_9\}$ | $(v'_3, v'_6) = 0$ | $S_3 : \{v_8, v'_3, v'_6, v_2, v_5, v_7\}$ |
| $(v'_3, v'_7) = 1$ | $\overline{S_3} : \{v_2, v_4, v'_3, v_1, v_5, v'_7\}$ | $(v'_3, v'_8) = 0$ | $\overline{S_3} : \{v_6, v'_3, v'_8, v_1, v_4, v_7\}$ |
| $(v'_4, v'_5) = 1$ | $S_3 : \{v_1, v_2, v'_4, v_6, v_9, v'_5\}$ | $(v'_4, v'_6) = 0$ | $\overline{S_3} : \{v_3, v_5, v'_4, v_1, v_9, v'_6\}$ |
| $(v'_4, v'_7) = 0$ | $S_3 : \{v_2, v'_7, v'_4, v_3, v_5, v_8\}$ | $(v'_4, v'_8) = 0$ | $\overline{S_3} : \{v_1, v_3, v_6, v_2, v'_4, v'_8\}$ |
| $(v'_5, v'_6) = 1$ | $S_3 : \{v_1, v_8, v'_6, v_4, v_0, v'_5\}$ | $(v'_5, v'_7) = 0$ | $S_3 : \{v_2, v'_5, v'_7, v_4, v_8, v_0\}$ |
| $(v'_5, v'_8) = 0$ | $\overline{S_3} : \{v_2, v'_5, v'_8, v_1, v_4, v_7\}$ | $(v'_6, v'_7) = 1$ | $S_3 : \{v_3, v_4, v'_6, v_8, v_0, v'_7\}$ |
| $(v'_6, v'_8) = 0$ | $\overline{S_3} : \{v_1, v_7, v'_8, v_3, v_9, v'_6\}$ | $(v'_7, v'_8) = 1$ | $S_3 : \{v_2, v_3, v'_8, v_6, v_9, v'_7\}$ |

Table 11: Case analysis for the connections between v'_1, \dots, v'_8 .

| | | | | | | | | | | |
|--------|-------|-------|-------|-------|-------|-------|-------|-------|-------|-------|
| | v_1 | v_2 | v_3 | v_4 | v_5 | v_6 | v_7 | v_8 | v_9 | v_0 |
| v'_0 | 0 | 0 | 0 | 1 | 0 | 0 | 0 | 1 | 0 | * |

Table 12: Connections between v'_0 and G_{10} .

| | | | | | | | | | | |
|--------|-------|-------|-------|-------|-------|-------|-------|-------|-------|-------|
| | v_1 | v_2 | v_3 | v_4 | v_5 | v_6 | v_7 | v_8 | v_9 | v_0 |
| v'_9 | 0 | 1 | 0 | 0 | 0 | 1 | 0 | 0 | 0 | * |

Table 13: Connections between v'_9 and G_{10} .

| | v'_1 | v'_2 | v'_3 | v'_4 | v'_5 | v'_6 | v'_7 | v'_8 | v'_9 | v'_0 |
|--------|--------|--------|--------|--------|--------|--------|--------|--------|--------|--------|
| v'_1 | — | 1 | 0 | 0 | 1 | 0 | 0 | 1 | 1 | 1 |
| v'_2 | 1 | — | 1 | 0 | 0 | 0 | 0 | 0 | 0 | 1 |
| v'_3 | 0 | 1 | — | 1 | 0 | 0 | 1 | 0 | 1 | 1 |
| v'_4 | 0 | 0 | 1 | — | 1 | 0 | 0 | 0 | 1 | 0 |
| v'_5 | 1 | 0 | 0 | 1 | — | 1 | 0 | 0 | 1 | 1 |
| v'_6 | 0 | 0 | 0 | 0 | 1 | — | 1 | 0 | 0 | 1 |
| v'_7 | 0 | 0 | 1 | 0 | 0 | 1 | — | 1 | 1 | 1 |
| v'_8 | 1 | 0 | 0 | 0 | 0 | 0 | 1 | — | 1 | 0 |
| v'_9 | 1 | 0 | 1 | 1 | 1 | 0 | 1 | 1 | — | 1 |
| v'_0 | 1 | 1 | 1 | 0 | 1 | 1 | 1 | 0 | 1 | — |

Table 14: Connections between vertices v'_1, \dots, v'_9, v'_0 .

| | v_1 | v_2 | v_3 | v_4 | v_5 | v_6 | v_7 | v_8 | v_9 | v_0 |
|--------|-------|-------|-------|-------|-------|-------|-------|-------|-------|-------|
| v'_1 | * | 0 | 1 | 1 | 0 | 1 | 1 | 0 | 0 | 0 |
| v'_2 | 0 | * | 0 | 1 | 1 | 1 | 1 | 1 | 1 | 0 |
| v'_3 | 1 | 0 | * | 0 | 1 | 1 | 0 | 1 | 0 | 0 |
| v'_4 | 1 | 1 | 0 | * | 0 | 1 | 1 | 1 | 0 | 1 |
| v'_5 | 0 | 1 | 1 | 0 | * | 0 | 1 | 1 | 0 | 0 |
| v'_6 | 1 | 1 | 1 | 1 | 0 | * | 0 | 1 | 1 | 0 |
| v'_7 | 1 | 1 | 0 | 1 | 1 | 0 | * | 0 | 0 | 0 |
| v'_8 | 0 | 1 | 1 | 1 | 1 | 1 | 0 | * | 0 | 1 |
| v'_9 | 0 | 1 | 0 | 0 | 0 | 1 | 0 | 0 | * | 0 |
| v'_0 | 0 | 0 | 0 | 1 | 0 | 0 | 0 | 1 | 0 | * |

Table 15: Connections between vertices v_1, \dots, v_9, v_0 and v'_1, \dots, v'_9, v'_0 .

v_1, \dots, v_9, v_0 and v'_1, \dots, v'_9, v'_0 in Table 15.

Table 16: Case analysis for the pairs (v'_0, v_1) , (v'_0, v_3) , (v'_0, v_4) , (v'_0, v_5) , (v'_0, v_7) and (v'_0, v_8) .

| (v'_0, v_1) | (v'_0, v_3) | (v'_0, v_4) | (v'_0, v_5) | (v'_0, v_7) | (v'_0, v_8) | S_3 or $\overline{S_3}$ |
|---------------|---------------|---------------|---------------|---------------|---------------|--|
| 0 | 0 | 0 | 0 | 0 | 0 | $S_3 : \{v_2, v_3, v'_5, v_1, v_4, v'_0\}$ |
| 0 | 0 | 0 | 0 | 0 | 1 | $S_3 : \{v_1, v_8, v_9, v_2, v_4, v'_0\}$ |
| 0 | 0 | 0 | 0 | 1 | 0 | $S_3 : \{v_2, v_3, v'_5, v_1, v_4, v'_0\}$ |
| 0 | 0 | 0 | 0 | 1 | 1 | $S_3 : \{v_1, v_8, v_9, v_2, v_4, v'_0\}$ |
| 0 | 0 | 0 | 1 | 0 | 0 | $S_3 : \{v_1, v_5, v_9, v_2, v_7, v'_0\}$ |
| 0 | 0 | 0 | 1 | 0 | 1 | $S_3 : \{v_1, v_5, v_9, v_2, v_7, v'_0\}$ |
| 0 | 0 | 0 | 1 | 1 | 0 | $S_3 : \{v_2, v_3, v'_5, v_1, v_4, v'_0\}$ |
| 0 | 0 | 0 | 1 | 1 | 1 | $S_3 : \{v_1, v_8, v_9, v_2, v_4, v'_0\}$ |
| 0 | 0 | 1 | 0 | 0 | 0 | $S_3 : \{v_3, v_4, v_9, v_2, v_8, v'_0\}$ |
| 0 | 0 | 1 | 0 | 0 | 1 | none |
| 0 | 0 | 1 | 0 | 1 | 0 | $S_3 : \{v_3, v_4, v_9, v_2, v_8, v'_0\}$ |
| 0 | 0 | 1 | 0 | 1 | 1 | $S_3 : \{v_3, v_7, v_9, v_2, v_5, v'_0\}$ |
| 0 | 0 | 1 | 1 | 0 | 0 | $S_3 : \{v_1, v_5, v_9, v_2, v_7, v'_0\}$ |
| 0 | 0 | 1 | 1 | 0 | 1 | $S_3 : \{v_1, v_5, v_9, v_2, v_7, v'_0\}$ |
| 0 | 0 | 1 | 1 | 1 | 0 | $S_3 : \{v_3, v_4, v_9, v_2, v_8, v'_0\}$ |
| 0 | 0 | 1 | 1 | 1 | 1 | $S_3 : \{v_4, v_5, v'_0, v_3, v_6, v_8\}$ |
| 0 | 1 | 0 | 0 | 0 | 0 | $S_3 : \{v_3, v_7, v_9, v_1, v_6, v'_0\}$ |
| 0 | 1 | 0 | 0 | 0 | 1 | $S_3 : \{v_1, v_8, v_9, v_2, v_4, v'_0\}$ |
| 0 | 1 | 0 | 0 | 1 | 0 | $\overline{S_3} : \{v_4, v_8, v'_0, v_3, v_7, v_9\}$ |
| 0 | 1 | 0 | 0 | 1 | 1 | $S_3 : \{v_1, v_8, v_9, v_2, v_4, v'_0\}$ |
| 0 | 1 | 0 | 1 | 0 | 0 | $S_3 : \{v_1, v_5, v_9, v_2, v_7, v'_0\}$ |
| 0 | 1 | 0 | 1 | 0 | 1 | $S_3 : \{v_1, v_5, v_9, v_2, v_7, v'_0\}$ |
| 0 | 1 | 0 | 1 | 1 | 0 | $S_3 : \{v_3, v_7, v'_0, v_2, v_5, v_8\}$ |
| 0 | 1 | 0 | 1 | 1 | 1 | $S_3 : \{v_1, v_8, v_9, v_2, v_4, v'_0\}$ |
| 0 | 1 | 1 | 0 | 0 | 0 | $S_3 : \{v_3, v_7, v_9, v_1, v_6, v'_0\}$ |
| 0 | 1 | 1 | 0 | 0 | 1 | $S_3 : \{v_3, v_4, v'_0, v_2, v_5, v_8\}$ |
| 0 | 1 | 1 | 0 | 1 | 0 | $S_3 : \{v_4, v_5, v_9, v_6, v_8, v'_0\}$ |
| 0 | 1 | 1 | 0 | 1 | 1 | $S_3 : \{v_3, v_4, v'_0, v_2, v_5, v_8\}$ |
| 0 | 1 | 1 | 1 | 0 | 0 | $S_3 : \{v_1, v_5, v_9, v_2, v_7, v'_0\}$ |
| 0 | 1 | 1 | 1 | 0 | 1 | $S_3 : \{v_1, v_5, v_9, v_2, v_7, v'_0\}$ |
| 0 | 1 | 1 | 1 | 1 | 0 | $S_3 : \{v_3, v_7, v'_0, v_2, v_5, v_8\}$ |
| 0 | 1 | 1 | 1 | 1 | 1 | $S_3 : \{v_3, v'_1, v'_0, v_2, v_6, v_8\}$ |
| 1 | 0 | 0 | 0 | 0 | 0 | $S_3 : \{v_1, v_5, v_9, v_3, v_6, v'_0\}$ |
| 1 | 0 | 0 | 0 | 0 | 1 | $S_3 : \{v_1, v_5, v_9, v_3, v_6, v'_0\}$ |
| 1 | 0 | 0 | 0 | 1 | 1 | $S_3 : \{v_1, v_5, v_9, v_3, v_6, v'_0\}$ |
| 1 | 0 | 0 | 1 | 0 | 0 | $S_3 : \{v_3, v_7, v'_1, v_2, v_8, v'_0\}$ |
| 1 | 0 | 0 | 1 | 0 | 1 | $S_3 : \{v_3, v_7, v'_5, v_4, v_6, v'_0\}$ |
| 1 | 0 | 0 | 1 | 1 | 0 | $S_3 : \{v_1, v_5, v'_0, v_2, v_4, v_7\}$ |

| (v'_0, v_1) | (v'_0, v_3) | (v'_0, v_4) | (v'_0, v_5) | (v'_0, v_7) | (v'_0, v_8) | S_3 or $\overline{S_3}$ |
|---------------|---------------|---------------|---------------|---------------|---------------|--|
| 1 | 0 | 0 | 1 | 1 | 1 | $S_3 : \{v_1, v_5, v'_0, v_2, v_4, v_7\}$ |
| 1 | 0 | 1 | 0 | 0 | 0 | $S_3 : \{v_1, v_5, v_9, v_3, v_6, v'_0\}$ |
| 1 | 0 | 1 | 0 | 0 | 1 | $S_3 : \{v_1, v_5, v_9, v_3, v_6, v'_0\}$ |
| 1 | 0 | 1 | 0 | 1 | 0 | $S_3 : \{v_1, v_5, v_9, v_3, v_6, v'_0\}$ |
| 1 | 0 | 1 | 0 | 1 | 1 | $S_3 : \{v_1, v_5, v_9, v_3, v_6, v'_0\}$ |
| 1 | 0 | 1 | 1 | 0 | 0 | $S_3 : \{v_3, v_4, v_9, v_2, v_8, v'_0\}$ |
| 1 | 0 | 1 | 1 | 0 | 1 | $S_3 : \{v_1, v_8, v'_0, v_2, v_4, v_7\}$ |
| 1 | 0 | 1 | 1 | 1 | 0 | $S_3 : \{v_3, v_4, v_9, v_2, v_8, v'_0\}$ |
| 1 | 0 | 1 | 1 | 1 | 1 | $S_3 : \{v_4, v_5, v'_0, v_3, v_6, v_8\}$ |
| 1 | 1 | 0 | 0 | 0 | 0 | $S_3 : \{v_6, v_7, v'_1, v_5, v_8, v'_0\}$ |
| 1 | 1 | 0 | 0 | 0 | 1 | $S_3 : \{v_3, v'_1, v'_0, v_2, v_6, v_8\}$ |
| 1 | 1 | 0 | 0 | 1 | 0 | $S_3 : \{v_3, v_7, v'_0, v_1, v_4, v_6\}$ |
| 1 | 1 | 0 | 0 | 1 | 1 | $S_3 : \{v_3, v_7, v'_0, v_1, v_4, v_6\}$ |
| 1 | 1 | 0 | 1 | 0 | 0 | $S_3 : \{v_1, v_5, v'_0, v_3, v_6, v_8\}$ |
| 1 | 1 | 0 | 1 | 0 | 1 | $S_3 : \{v_3, v'_1, v'_0, v_2, v_6, v_8\}$ |
| 1 | 1 | 0 | 1 | 1 | 0 | $S_3 : \{v_1, v_5, v'_0, v_2, v_4, v_7\}$ |
| 1 | 1 | 0 | 1 | 1 | 1 | $S_3 : \{v_1, v_5, v'_0, v_2, v_4, v_7\}$ |
| 1 | 1 | 1 | 0 | 0 | 0 | $S_3 : \{v_4, v_5, v_9, v_6, v_8, v'_0\}$ |
| 1 | 1 | 1 | 0 | 0 | 1 | $S_3 : \{v_1, v_8, v'_0, v_2, v_4, v_7\}$ |
| 1 | 1 | 1 | 0 | 1 | 0 | $S_3 : \{v_4, v_5, v_9, v_6, v_8, v'_0\}$ |
| 1 | 1 | 1 | 0 | 1 | 1 | $S_3 : \{v_3, v_4, v'_0, v_2, v_5, v_8\}$ |
| 1 | 1 | 1 | 1 | 0 | 0 | $S_3 : \{v_1, v_5, v'_0, v_3, v_6, v_8\}$ |
| 1 | 1 | 1 | 1 | 0 | 1 | $S_3 : \{v_1, v_8, v'_0, v_2, v_4, v_7\}$ |
| 1 | 1 | 1 | 1 | 1 | 0 | $S_3 : \{v_1, v_5, v'_0, v_3, v_6, v_8\}$ |
| 1 | 1 | 1 | 1 | 1 | 1 | $S_3 : \{v_3, v'_1, v'_0, v_2, v_6, v_8\}$ |

Interestingly, the graph induced by v'_1, \dots, v'_9, v'_0 is an isomorphic copy of G_{10} . Moreover, (v_i, v'_j) for $i \neq j$ is an edge if and only if (v_i, v_j) is not an edge, while the pairs (v_i, v'_i) , $i = 0, 1, \dots, 9$ are uncertain. Thus, this configuration is the sum of two copies of G_{10} , that is, the graph $2G_{10}$ (see Figure 29). Let us recall that to any graph G we can apply the same operation and obtain the sum $G + G = 2G$.

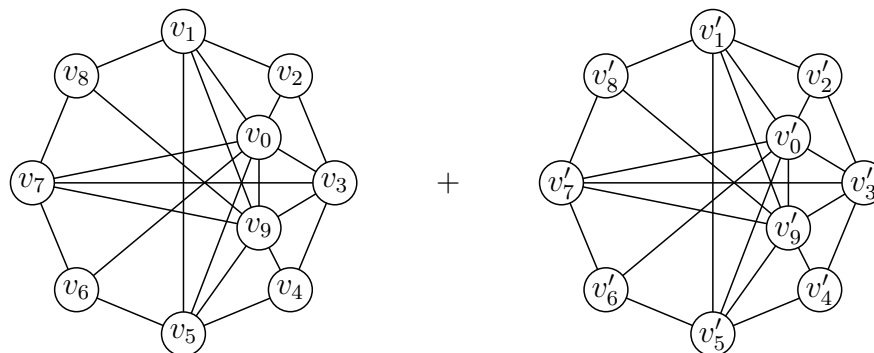

Figure 29: The sum of two graphs G_{10} or $2G_{10}$.

Another remarkable property of the obtained configuration is as follows: if we exchange v_0 with v'_0 and v_9 with v'_9 then the resulting graph becomes the sum of two Petersen graphs, that is, $2\mathcal{P} \equiv 2G_{10}$, as shown in Figure 30.

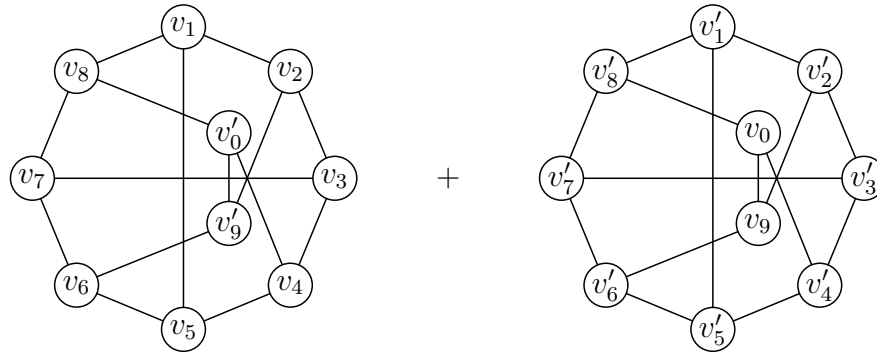

Figure 30: The graph $2\mathcal{P}$, isomorphic to $2G_{10}$ by exchanging v_0, v'_0 and v_9, v'_9 .

This completes the proof of Lemma 3. □

2.4 Proof of Lemma 4

We prove that if a graph G contains an induced $2\mathcal{P}$, then it must have either an unsettled 2-comb, or an induced 3-comb or 3-anti-comb.

Let us recall that $2\mathcal{P}$ still has 10 uncertain edges. Hence, it gives us in fact 1024 possible graphs, one of which is an induced subgraph of G . Since we do not know which one, we will prove the statement by considering each such possible subgraphs.

Remarkably, none of these 1024 graphs contains an induced 3-comb or 3-anti-comb, as verified by computer.

Furthermore, $2\mathcal{P}$ itself contains no induced 2-combs either. (Since $2\mathcal{P}$ contains uncertain pairs, we call a subgraph of $2\mathcal{P}$ an induced one only if it does not involve any uncertain pair.) However, each of the 1024 graphs obtained from $2\mathcal{P}$ contains many 2-combs each of which involves exactly one pair of vertices v_i and v'_i for some index i .

Now we will fix one of the uncertain pairs (once as an edge and once as a non-edge), while keeping all others uncertain. Several (36) unsettled induced 2-combs appear that contain the fixed uncertain pair. Each of these 2-combs must be settled in G by our assumption (i), thus there exists a vertex x settling it. There are 16 pairs (x, y) , where y is a vertex of $2\mathcal{P}$, not belonging to the unsettled 2-comb. We check all 2^{16} possible edge/non-edge assignments to these 16 pairs, and find by computer search that for each of them an induced 3-comb or 3-anti-comb exists.

More precisely, let us fix the uncertain pair (v_0, v'_0) and consider two cases:

1. If (v_0, v'_0) is an edge then the 2-comb induced by the vertices $\{v_1, v_0, v'_0, v_4\}$ is unsettled in $2\mathcal{P}$, because no vertex in $2\mathcal{P}$ is connected to both v_0 and v'_0 by the definition of the sum of two graphs.

Let x be a settling vertex. Then, by definition, (x, v_0) , (x, v'_0) must be edges of G , and the pairs (x, v_1) and (x, v_4) must be non-edges. There are 16 other pairs of the form (x, y) , where y is a vertex of $2\mathcal{P}$. Hence, there are 2^{16} possible assignments of edges/non-edges between x and $2\mathcal{P}$. We check by computer all 2^{16} possible assignments and find that in each 2^{16} graphs there is an induced (without uncertain pairs) 3-comb or 3-anti-comb.

2. If (v_0, v'_0) is not an edge of G then the 2-comb induced by the vertices $\{v_0, v_1, v_8, v'_0\}$ is not settled in $2\mathcal{P}$. Since it must be settled in G by condition (i), there is a vertex x of G that settles it. Similarly to the previous case, we again consider all 2^{16} graphs, and find by computer search that all of them contain an induced 3-comb or 3-anti-comb.

This concludes the proof of Lemma 4. □

3 Proof of Theorems 2 and 3

Proof of Theorem 2: Recall by (1.1) that we can reduce the case analysis by assuming that $1 \leq k < \ell \leq n - 2$.

We start by proving (i). Assume by contradiction that there exists an unsettled $\overline{S_m} = \{B_1, \dots, B_m, A_1, \dots, A_m\}$, $|B_i| = k$, $|A_i| = \ell$. Then, by assumption we must have

$$A_i \supset B_j \text{ for all } j \neq i \quad \text{and} \quad A_i \not\supset B_i. \quad (3.9)$$

Let us recall that $\overline{S_m}$ is settled by a k -set K iff $K \subseteq \bigcap_{j=1}^m A_j$, and it is settled by an ℓ -set L iff $L \not\supset B_i$ for $i = 1, \dots, m$.

Let $\mathcal{B} = \{B_1, \dots, B_m\}$, and let $X \subseteq [n]$ be the set that contains the elements that are in more than one of the B_i 's, i.e. $X = \{x \in [n] \mid \deg_{\mathcal{B}}(x) > 1\}$. Notice that $X \subseteq \bigcap_{j=1}^m A_j$ because by (3.9) we have that every vertex belonging to two or more of the sets from \mathcal{B} must belong to all sets A_i , $i = 1, \dots, m$. Clearly $|X| < k$, otherwise $\overline{S_m}$ would be settled by a k -set in X .

In the following steps of the proof, we will derive some inequalities, to arrive to a contradiction. First, we need some more definitions.

Let a_p , $p = 0, 1, \dots, q \leq |X| < k$, be the number of sets $B_i \in \mathcal{B}$ for which $|B_i \cap X| = p$, and let $\mathcal{H} = \{B_i \cap X \mid i = 1, \dots, m\}$. Let us observe first that $\tau(\mathcal{B}) \leq \tau(\mathcal{H}) + a_0$, where τ denotes the size of a minimum vertex cover. To see this inequality, let us first cover the intersecting hyperedges of \mathcal{B} optimally by $\tau(\mathcal{H})$ vertices, and then cover the rest by choosing one vertex from each remaining set outside of X (i.e., by at most a_0 additional vertices). Moreover, we have $\tau(\mathcal{B}) > n - \ell$, since otherwise there exists an ℓ -set settling $\overline{S_m}$. Thus, we can conclude that

$$\tau(\mathcal{H}) + a_0 \geq n - \ell + 1 \quad (3.10)$$

Assume w.l.o.g. that $|B_1 \cap X| \leq |B_2 \cap X| \leq \dots \leq |B_m \cap X|$. Since we know by (3.9)

that $\bigcup_{j=1}^{m-1} B_j \subseteq A_m$, we have:

$$\left| \bigcup_{i=1}^{m-1} B_j \right| = |X| + \sum_{p=0}^q (k-p)a_p - (k-q) \leq \ell \quad (3.11)$$

Let us now take away k times equation (3.10) from (3.11) and obtain

$$|X| + \sum_{p=0}^q (k-p)a_p - (k-q) - k(\tau(\mathcal{H}) + a_0) \leq \ell - k(n - \ell + 1)$$

which can be simplified to

$$|X| + \sum_{p=1}^q (k-p)a_p + q - k\tau(\mathcal{H}) \leq (k+1)\ell - kn \quad (3.12)$$

Notice that the right hand side of (3.12) is negative by our initial assumption of $kn > (k+1)\ell$. Thus, to arrive to a contradiction, it is enough to prove that

$$k\tau(\mathcal{H}) \leq |X| + \sum_{p=1}^q (k-p)a_p + q. \quad (3.13)$$

Let us observe next that $\sum_{p=1}^q (k-p)a_p = k|\mathcal{H}|$, and that $\sum_p (p a_p) = \sum_{H \in \mathcal{H}} |H|$. Thus, we can equivalently rewrite inequality (3.13) as:

$$k(|\mathcal{H}| - \tau(\mathcal{H})) \geq \sum_{H \in \mathcal{H}} |H| - |X| - q \quad (3.14)$$

To show (3.14), let us construct a cover C of \mathcal{H} as follows. First we choose into C a vertex of the highest degree in \mathcal{H} . This vertex covers at least $\frac{\sum_{H \in \mathcal{H}} |H|}{|X|}$ hyperedges of \mathcal{H} . We cover the remaining edges by choosing one vertex from each. This simple procedure shows that

$$\tau(\mathcal{H}) \leq |C| \leq |\mathcal{H}| - \frac{\sum_{H \in \mathcal{H}} |H|}{|X|} + 1. \quad (3.15)$$

From this simple inequality we can derive the following:

$$\begin{aligned} k(|\mathcal{H}| - \tau(\mathcal{H})) &\geq \frac{k}{|X|} \sum_{H \in \mathcal{H}} |H| - k \\ &= \sum_{H \in \mathcal{H}} |H| + \frac{k-|X|}{|X|} \sum_{H \in \mathcal{H}} |H| - k \\ &\geq \sum_{H \in \mathcal{H}} |H| - |X| \end{aligned}$$

where, the second inequality follows from $|X| \leq \sum_{H \in \mathcal{H}} |H|$, which is true, since every vertex of X has degree at least 2 in \mathcal{B} . The above inequalities then prove (3.14), since $q \geq 0$, which then yields the desired contradiction, completing the proof of (i). \square

We prove next (ii). We will show, by a construction that an unsettled $\overline{S_m}$ exists in $G(n, k, \ell)$, whenever $kn \leq (k+1)\ell$ and $n \geq k + \ell$.

For this let us set $r \equiv \ell \pmod{k}$, $0 \leq r < k$, $m = \frac{\ell+k-r}{k}$, and let B_1, \dots, B_m , and R be pairwise disjoint subsets of $[n] = \{1, 2, \dots, n\}$, such that $|R| = r$ and $|B_i| = k$ for $i = 1, \dots, m$. Notice that

$$|R \cup B_1 \cup \dots \cup B_m| = km + r = \ell + k. \quad (3.16)$$

Thus, it is possible to choose such pairwise disjoint subsets, since $k+\ell \leq n$ by our assumption. Let us further define

$$A_i = R \cup \left(\bigcup_{j \neq i} B_j \right) \quad \text{for } i = 1, \dots, m.$$

With these definitions, we have $|A_i| = r + k(m-1) = r + (\ell - r) = \ell$ for all $i = 1, \dots, m$. Furthermore, $A_i \supseteq B_j$ if and only if $i \neq j$. Thus, the sets A_1, \dots, A_m , and B_1, \dots, B_m are vertices of $G(m, k, \ell)$ forming an $\overline{S_m}$.

We show that this $\overline{S_m}$ is unsettled in $G(n, k, \ell)$. For this, observe first that $|\bigcap_{i=1}^m A_i| = |R| = r < k$, and consequently, no k -set can settle $\overline{S_m}$.

Next, let us assume indirectly that there is an ℓ -set L which settles $\overline{S_m}$. Hence, L cannot be connected in $G(n, k, \ell)$ to any of the B_i 's. In other words, $L \not\supseteq B_i$ for $i = 1, \dots, m$. It follows that $|L \cap B_i| \leq k-1$ for all $i = 1, \dots, m$, implying

$$|L| \leq m(k-1) + r + (n - k - \ell). \quad (3.17)$$

That is, we can take at most $k-1$ elements from each of the k -sets, and the remaining $r + n - k - \ell$ elements of $[n]$, as implied by (3.16). It is now enough to show that $|L| < \ell$, because this contradicts the assumption that L is an ℓ -set. To do this, let us rewrite (3.17) as

$$|L| \leq m(k-1) + r + (n - k - \ell) = \frac{\ell + k - r}{k}(k-1) + r - n - k - \ell,$$

which implies

$$\begin{aligned} k|L| + \ell &\leq (\ell + k - r)(k-1) + k(r - n - k - \ell) + \ell \\ &= k\ell - \ell + k^2 - k - kr + r + kr + kn - k^2 - k\ell + \ell \\ &= kn - (k - r) < kn \leq (k+1)\ell \end{aligned}$$

where the last two inequalities follow by $k > r$ and our assumption that $kn \leq (k+1)\ell$. Thus, $|L| < \ell$ follows, completing the proof of (ii). \square

This completes the proof of Theorem 2. \square

Proof of Theorem 3:

We prove first (a). Even though this claim is only for $k \leq 2$, let us first disregard this restriction. Assume by contradiction that there exists an unsettled S_m in $G(m, k, \ell)$ defined by the sets $\{B_1, \dots, B_m, A_1, \dots, A_m\}$, where $|B_i| = k$, $|A_i| = \ell$, for $i = 1, \dots, m$, and $B_j \subseteq A_i$, iff $i = j$. Set $\mathcal{B} = \{B_1, \dots, B_m\}$ and $\mathcal{A} = \{A_1, \dots, A_m\}$.

By definitions, an ℓ -set L can settle S_m only if $[n] \setminus L$ is a vertex cover of the hypergraph \mathcal{B} . Furthermore, a k -set K can settle S_m , only if $K \subseteq A_i$ for all $i = 1, \dots, m$. Since S_m is assumed to be unsettled in $G(n, k, \ell)$, we must have the following properties.

- (i) $\tau(\mathcal{B}) \geq n - \ell + 1$, since otherwise the complement of a minimum vertex cover of \mathcal{B} would contain a settling ℓ -set.
- (ii) $|\bigcap_{i=1}^m A_i| < k$, since otherwise the intersection of the sets of \mathcal{A} would contain a settling k -set.

Let us also observe that $B_j \subseteq A_i$ if and only if $i = j$ implies that $\overline{A_i} = [n] \setminus A_i$ is a vertex cover for $\mathcal{B} \setminus B_i$, implying $|\overline{A_i}| = n - \ell \geq \tau(\mathcal{B} \setminus \{B_i\}) \geq \tau(\mathcal{B}) - 1$. This, together with (i), implies that

$$n - \ell = \tau(\mathcal{B}) - 1 = \tau(\mathcal{B} \setminus \{B_i\}) \tag{3.18}$$

for all $i = 1, \dots, m$.

Let us now consider the subset

$$X = [n] \setminus \bigcup_{i=1}^m B_i.$$

Equations (3.18) imply that $X \subseteq A_i$ for all $i = 1, \dots, m$. Thus, by property (ii) we must have

$$|X| \leq k - 1 \tag{3.19}$$

Another consequence of (3.18) is that the hypergraph \mathcal{B} is τ -critical, i.e., the minimum vertex cover size strictly decreases whenever we remove a hyperedge from \mathcal{B} . This also implies that \mathcal{B} is α -critical, where $\alpha(\mathcal{B})$ is the size of the largest *independent set* of \mathcal{B} , i.e., the largest set not containing a hyperedge of \mathcal{B} . This is because $\alpha(\mathcal{B}) + \tau(\mathcal{B}) = n$ for all hypergraphs \mathcal{B} .

Let us now consider the case of $k = 1$. In this case we have $|\mathcal{B}| = \tau(\mathcal{B})$ and by (3.19) $X = \emptyset$, implying that $|\mathcal{B}| = n$, which together with the previous equality and (3.18) imply

$$n = |\mathcal{B}| = \tau(\mathcal{B}) = n - \ell + 1$$

from which $\ell = 1$ follows, contradicting (1.1).

Let us next consider the case of $k = 2$. In this case \mathcal{B} is an α -critical graph G on vertex-set $V = [n] \setminus X$, with $\alpha(G) = \alpha(\mathcal{B}) - |X| = \ell - 1 - |X|$.

We apply a result attributed to Erdős and Gallai (see Exercise 8.20 in [31]; see also the proof of Exercise 8.10 by Hajnal), stating that in an α -critical graph G with no isolated vertices we have $|V| \geq 2\alpha(G)$. This implies for our case that $n - |X| \geq 2(\ell - 1 - |X|)$, from which

$$n \geq 2\ell - 2 - |X|$$

follows. Since by (3.19) we have $|X| \leq k - 1 = 1$, the above inequality implies

$$n \geq 2\ell - 3$$

contradicting (a) of Theorem 3, according to which we have $n < 2\ell - 3$. \square

Remark 10. *We could extend the above line of arguments for $k \geq 3$, if the inequality $n \geq \frac{k}{k-1}\alpha(\mathcal{B})$ were valid for α -critical k -uniform hypergraphs, in general. However, this is not the case, as the following example shows: let $n = 10$, $k = 3$ and $\mathcal{B} = \{\{1, 2, 3\}, \{3, 4, 5\}, \{5, 6, 7\}, \{7, 8, 9\}, \{9, 10, 1\}\}$. In this case we have $\alpha(\mathcal{B}) = 7$, and $10 \not\geq (3/2)7 = 21/2$.*

We prove finally (b). We will now provide a construction for an unsettled S_m . Let $L = \{2, 3, \dots, k\}$, and choose $r \in L$, such that $r \equiv \ell \pmod{k-1}$ (for instance, if $k = 2$ then we have $r = 2$).

Let us next partition $[n]$ as

$$[n] = X \cup \bigcup_{j=1}^p Q_j,$$

where $|X| = r - 1$, $p = \frac{\ell - r}{k - 1}$, and where the sets Q_1, \dots, Q_p are almost equal, i.e., $|Q_i| \sim \frac{n - r + 1}{p}$.

Then, we construct an unsettled $S_m = \{B_1, \dots, B_m, A_1, \dots, A_m\}$ as follows. We define $m = \sum_{j=1}^p \binom{|Q_j|}{k}$, and the sets B_i , $i = 1, \dots, m$ are the k -subsets of the Q_j -s, i.e.,

$$\{B_1, \dots, B_m\} = \bigcup_{i=1}^p \binom{Q_i}{k}.$$

Finally, we set for $i = 1, \dots, m$

$$A_i = X \cup B_i \cup \bigcup_{\substack{1 \leq j \leq p \\ j \neq j^*}} R_{ij},$$

where $B_i \subseteq Q_{j^*}$ and $R_{ij} \subseteq Q_j$, $|R_{ij}| = k - 1$ for all $j \neq j^*$. In other words, each A_i contains X , the corresponding set B_i , and $k - 1$ points from each set Q_j not containing B_i .

It is easy to see that $|A_i| = \ell$. Indeed,

$$\begin{aligned} |A_i| &= k + r - 1 + (p - 1)(k - 1) \\ &= k + r - 1 + \left(\frac{\ell - r}{k - 1} - 1 \right) (k - 1) \\ &= r + \ell - r = \ell \end{aligned}$$

Let us observe first that by the above calculations no ℓ -set can settle S_m . This is because all ℓ -sets must intersect at least one of the Q_j 's in k or more points, therefore any ℓ -set contains at least one of the B_i 's.

Furthermore, we can show that $|Q_j| \geq k$, for $j = 1, \dots, p$. By our assumption we have $n(k-1) \geq \ell k - r - k + 1$ from which we can derive the following chain of inequalities:

$$\begin{aligned} n &\geq \ell \frac{k}{k-1} - \frac{k+r-1}{k-1} \\ n(k-1) &\geq k\ell - k - r + 1 \\ n(k-1) - kr + k + r - 1 &\geq k\ell - kr \\ (n-r+1)(k-1) &\geq k\ell - kr \\ (n-r+1) &\geq k \frac{\ell-r}{k-1} = kp \\ \frac{n-r+1}{p} &\geq k, \end{aligned}$$

which implies that $|Q_j| \geq \lfloor \frac{n-r+1}{p} \rfloor \geq k$.

Finally we have to prove that no k -set can settle S_m . For this, as we remarked earlier, it is enough to show that $|\bigcap_{i=1}^m A_i| < k$, which will follow from

$$\left(\bigcap_{i=1}^m A_i \right) \cap Q_j = \emptyset \quad (3.20)$$

for $j = 1, \dots, p$, since then $(\bigcap_{i=1}^m A_i) \subseteq X$ is implied, and we have $|X| = k-1$.

To see (3.20) let us consider the following cases:

Case 1. If $|Q_j| > k$ then for all $v \in Q_j$, there is an index i such that $B_i \subset Q_j \setminus \{v\}$, implying by the definitions that $v \notin A_i$. Hence, (3.20) follows.

Case 2. If $|Q_j| = k$ and $m \geq k+1$, then we have $Q_j = B_{i^*}$ for exactly one index $i^* \in \{1, \dots, m\}$. For all other indices i we have $Q_j \cap A_i = R_{ij}$ of size $k-1$. Thus, since $m \geq k+1$, we can choose for each $v \in Q_j$ an index $i \neq i^*$ such that $v \notin A_i$, implying (3.20).

Case 3. If $m \leq k$ then we must have $|Q_1| = |Q_2| = \dots = |Q_p| = k$, $m = p \leq k$, since we already know that $|Q_j| \geq k$ for all $j = 1, \dots, p$, and if $|Q_j| > k$ for at least one index j , then $m \geq k+1$ would be implied. Thus, we have

$$\begin{aligned} n &= |X| + \sum_{i=1}^p |Q_i| \\ &= r-1 + pk \\ &= r-1 + k \frac{\ell-r}{k-1} \\ &= \ell \frac{k}{k-1} - \frac{r}{k-1} - 1, \end{aligned}$$

and hence, by our assumption, we must have $\ell \geq r + k^2 - k + 1$. However, $p \leq k$ implies that $p = \frac{\ell-r}{k-1} \leq k$ from which $\ell \leq r + k^2 - k$ follows. \square

This completes the proof of Theorem 3. \square

4 More about CIS- d -graphs

4.1 Proofs of Propositions 6,7, 11 and Theorem 4

Proof of Proposition 6. Obviously, every partition of colors can be realized by successive identification of two colors. Hence, the following Lemma implies Proposition 6.

Given a $(d+1)$ -graph $\mathcal{G} = (V; E_1, \dots, E_d, E_{d+1})$, let us identify the last two colors d and $d+1$ and consider the d -graph $\mathcal{G}' = (V; E_1, \dots, E_{d-1}, E_d)$, where $E_d = E_d \cup E_{d+1}$.

Lemma 5. *If \mathcal{G} is a CIS- $(d+1)$ -graph then \mathcal{G}' is a CIS- d -graph.*

Proof. Suppose that \mathcal{G}' does not have the CIS- d -property, that is, there are d vertex-sets $C_1, \dots, C_{d-1}, C_d \subseteq V$ such that they have no vertex in common, where C_i is a maximal subset of V avoiding color i for $i = 1, \dots, d-1$, and C_d is a maximal subset of V avoiding both colors d and $d+1$. Clearly, there exist maximal vertex-sets C_d and C_{d+1} avoiding colors d and $d+1$ respectively and such that $C_d \cap C_{d+1} = C_d$. Then $C_1, \dots, C_{d-1}, C_d, C_{d+1} \subseteq V$ are maximal vertex-sets avoiding colors $1, \dots, d-1, d, d+1$ respectively and with no vertex in common. Hence, the $(d+1)$ -graph \mathcal{G} does not have the CIS- $(d+1)$ -property, either. \square

A little later we will need the following similar claim.

Lemma 6. *If \mathcal{G} is a Gallai $(d+1)$ -graph then \mathcal{G}' is a Gallai d -graph.*

Proof. It is obvious. If \mathcal{G}' contains a Δ then the same three vertices form a Δ in \mathcal{G} too. \square

Proof of Proposition 7. It follows by a routine case analysis from the definitions.

First, let us consider Gallai's property. Suppose that \mathcal{G} has a Δ . Clearly, it cannot contain exactly one edge in \mathcal{G}'' , since then two remaining edges are of the same color. If this Δ contains 2 edges in \mathcal{G}'' then the third one is there, too, and hence \mathcal{G}'' contains a Δ . If all 3 edges are in \mathcal{G}' then \mathcal{G}' contains a Δ . Conversely, If \mathcal{G}' or \mathcal{G}'' contains a Δ then, clearly, \mathcal{G} contains it too, since both \mathcal{G}' and \mathcal{G}'' are induced subgraphs of \mathcal{G} .

Now let us consider the CIS-property. To simplify the notation we restrict ourselves by the case $d = 2$, though exactly the same arguments work in general. It is easy to see that any maximal cliques (respectively, stable sets) of \mathcal{G}' which do not contain v remain unchanged in \mathcal{G} , while a maximal clique C' (respectively, a maximal stable set S') of \mathcal{G}' which contains v and for every maximal clique C'' (respectively, every maximal stable set S'') of \mathcal{G}'' the set $C = C' \cup C'' \setminus \{v\}$ (respectively, $S = S' \cup S'' \setminus \{v\}$) is a maximal clique (respectively, a maximal stable set) of \mathcal{G} and moreover, there are no other maximal cliques (respectively, maximal stable sets) in \mathcal{G} .

It is not difficult to verify that every maximal clique $C = C' \cup C'' \setminus \{v\}$ and every maximal stable set $S = S' \cup S'' \setminus \{v\}$ in \mathcal{G} intersect if and only if every maximal clique C' intersects every a maximal stable set S' of \mathcal{G}' and every maximal clique C'' intersects every a maximal stable set S'' of \mathcal{G}'' . Indeed, if $C' \cap S' = \{v\} \neq \emptyset$ then $C \cap S = \{v\}$ for any C'' and S'' . If $C' \cap S' = \emptyset$ then $C \cap S = C'' \cap S''$ and hence $C \cap S \neq \emptyset$ if and only if $C'' \cap S'' \neq \emptyset$. If $C \cap S \neq \emptyset$ then both $C' \cap S'$ and $C'' \cap S''$ must be non-empty. \square

Proof of Theorem 4.

Part (a). By Proposition 7, \mathcal{G} is exactly closed under substitution. By Proposition 9, \mathcal{G} can be obtained from 2-graphs by substitutions. Such a decomposition of \mathcal{G} is given by a tree $T(\mathcal{G})$ whose leaves correspond to 2-graphs. It is easy to see that by construction each chromatic component of \mathcal{G} is decomposed by the same tree $T(\mathcal{G})$. Hence, all we have to prove is that both chromatic components of every 2-graph belong to \mathcal{F} . For colors $1, \dots, d-1$ this holds, since \mathcal{F} is exactly closed under substitution, and for the color d it holds, too, since \mathcal{F} is also closed under complementation.

Part (b). It follows easily from part (a). As in Lemma 5, given a $(d+1)$ -graph $\mathcal{G} = (V; E_1, \dots, E_d, E_{d+1})$, let us identify the last two colors d and $d+1$ and consider the d -graph $\mathcal{G}' = (V; E_1, \dots, E_{d-1}, E_d)$, where $E_d = E_d \cup E_{d+1}$. We assume that \mathcal{G} is Δ -free and that $G_i = (V, E_i) \in \mathcal{F}$ for $i = 1, \dots, d-1$. Then, by Lemma 6, \mathcal{G}' is Δ -free, too, and it follows from part (a) that $G_d = (V, E_d)$ is also in \mathcal{F} . Hence, the union of any two colors is in \mathcal{F} . From this by induction we derive that the union of any set of colors is in \mathcal{F} . \square

Proof of Proposition 11. Given \mathcal{G} , let us again consider the decomposition tree $T(\mathcal{G})$, fix an arbitrary its leaf v , and consider the corresponding 2-graph \mathcal{G}_v . Both its chromatic components are CIS-graphs, by Proposition 8. Hence, \mathcal{G}_v is a CIS- d -graph. Thus, \mathcal{G} is a CIS- d -graph, too, by Proposition 7. \square

4.2 Settling Δ

Let $V = \{v_1, v_2, v_3\}$ and assume that $E_1 = \{(v_1, v_2)\}$, $E_2 = \{(v_2, v_3)\}$, and $E_3 = \{(v_3, v_1)\}$ form a Δ , see Figure 12. Obviously, Δ is not a CIS-3-graph. Indeed, let us consider $C_1 = \{v_2, v_3\}$, $C_2 = \{v_3, v_1\}$, and $C_3 = \{v_1, v_2\}$. There is no edge from E_i in C_i for $i = 1, 2, 3$ and $C_1 \cap C_2 \cap C_3 = \emptyset$. Hence, if a CIS-3-graph $\mathcal{G} = (V; E_1, E_2, E_3)$ contains a Δ then it must contain a vertex v_4 such that the sets $C'_1 = \{v_2, v_3, v_4\}$, $C'_2 = \{v_3, v_1, v_4\}$, and $C'_3 = \{v_1, v_2, v_4\}$ contain no edges from E_1 , E_2 , and E_3 , respectively.

Similarly, let us consider the sets $C_1 = \{v_3, v_1\}$, $C_2 = \{v_1, v_2\}$, and $C_3 = \{v_2, v_3\}$. Again, there is no edge from E_i in C_i for $i = 1, 2, 3$ and $C_1 \cap C_2 \cap C_3 = \emptyset$. Hence, if a CIS-3-graph $\mathcal{G} = (V; E_1, E_2, E_3)$ contains a Δ then it must contain a vertex v_5 such that $C'_1 = \{v_3, v_1, v_5\}$, $C'_2 = \{v_1, v_2, v_5\}$, and $C'_3 = \{v_2, v_3, v_5\}$ contain no edges from E_1 , E_2 , and E_3 , respectively.

It is easy to check that $v_4 \neq v_5$ and that we must have $(v_4, v_1), (v_1, v_2), (v_2, v_5) \in E_1$, $(v_4, v_2), (v_2, v_3), (v_3, v_5) \in E_2$, $(v_4, v_3), (v_3, v_1), (v_1, v_5) \in E_3$, see Figure 12. This leaves only one pair (v_4, v_5) whose color is not implied. Yet, let us note that for any coloring of (v_4, v_5) a new Δ appears. For example, if $(v_4, v_5) \in E_1$ then vertices (v_3, v_4, v_5) form a Δ' .

4.3 A stronger conjecture

We say that two vertices v_4 and v_5 settle Δ . Note however that v_1 and v_2 do not settle Δ' . So we need more vertices to settle it. Nevertheless, there are d -graphs whose all Δ s are settled. First such example was given by Andrey Gol'berg in 1984, see Figure 34.

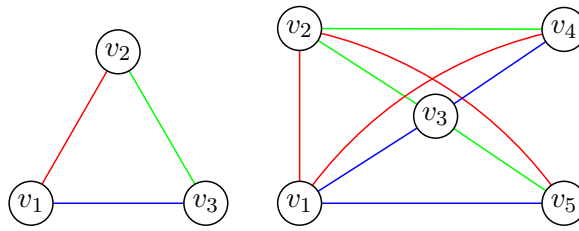

Figure 31: Settling Δ .

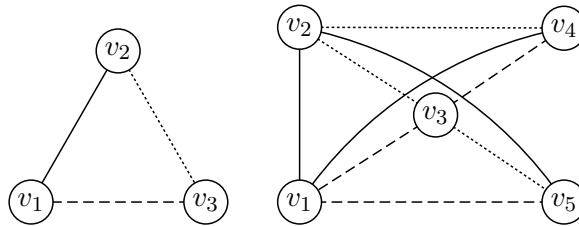

Figure 32: Settling Δ (in black and white for printing).

We call this construction a 4-cycle. It has 4 Δ s and they are all settled. Yet, if we partition its three colors into two sets we will get 44 2-combs none of which is settled. Hence, by Proposition 6, the 4-cycle is not a CIS-3-graph.

Moreover, in the next section we give examples of 3-graphs whose all Δ s and 2-combs are settled, however, their 2-projections have unsettled induced 3-combs or 3-anti-combs.

Conjecture 4. *Let \mathcal{G} be a non-Gallai 3-graph with chromatic components G_1, G_2, G_3 , then there is an unsettled Δ in \mathcal{G} or G_i has an unsettled induced comb or anti-comb for some $i = 1, 2, 3$.*

Obviously, Proposition 6 and Conjecture 4 imply Conjecture 3.

Remark 11. *It is not difficult to show that for every fixed $k, d \in \mathbf{Z}_+$ and $\epsilon > 0$ there is $n = n(k, d, \epsilon)$ such that in a random d -graph \mathcal{G} with a fixed $|V(\mathcal{G})| \geq k$ all Δ s as well as all induced m -combs and m -anti-combs for $m \leq k$ in all projections of \mathcal{G} are settled with probability greater than $1 - \epsilon$.*

Yet, for $m > k$, unsettled induced m -combs and m -anti-combs exist with high probability.

4.4 Even cycles and flowers

In this section we describe some interesting 3-graphs in support of Conjecture 4. They have all Δ s settled, and sometimes even all 2-combs are settled in their 2-projections. However, then unsettled 3-combs, or 3-anti-combs, or 4-combs appear.

Let us consider four Δ s in Figure 33. They form a cycle.

This construction can be extended (uniquely) to a 3-graph, shown in Figure 35, in which all four Δ s are settled “counterclockwise” (i.e., Δ s induced by the triplets $\{0, 1, 2\}$, $\{2, 3, 4\}$,

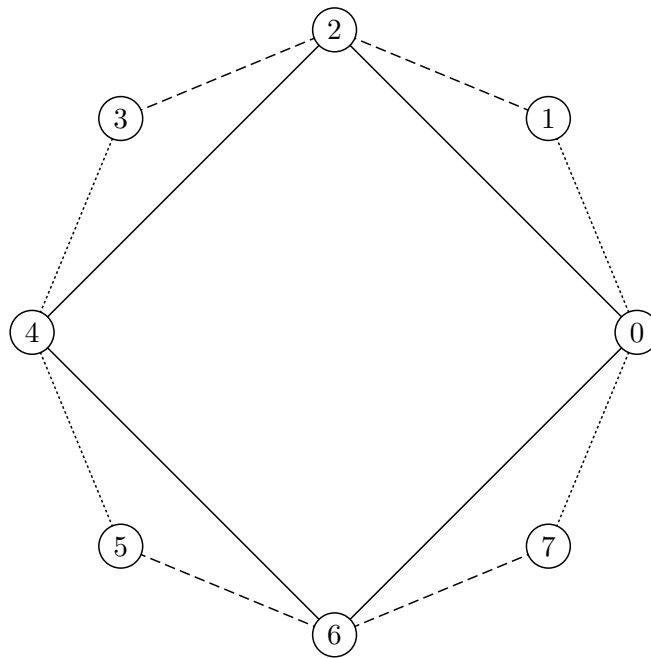

Figure 33: Initial 4-cycle structure.

$\{4, 5, 6\}$, and $\{6, 7, 0\}$ are settled by the pairs $\{3, 4\}$, $\{5, 6\}$, $\{7, 1\}$, and $\{1, 2\}$, respectively), and no new Δ appears. However, 2-projections of this 3-graph contain 44 unsettled 2-combs (induced by the quadruples $\{0, 5, 1, 4\}$, $\{3, 2, 6, 7\}$, $\{4, 1, 2, 3\}$, $\{0, 5, 6, 7\}$, etc.) as shown in Figure 35.

Level 1: GBBGBBG
 Level 2: RGRBRGRB
 Level 3: RBRGRBRG
 Level 4: GBBRGGBR

4 settled Δ s
 44 S_2 : 0 settled

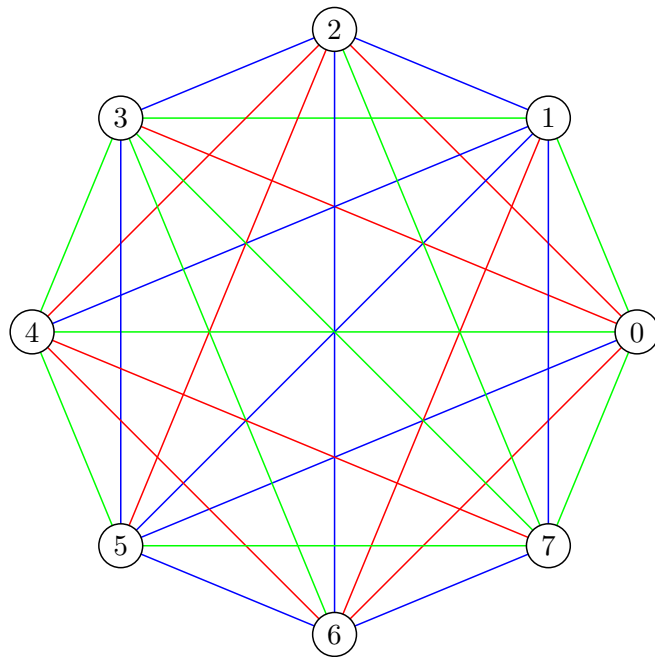

Figure 34: 4-cycle with all Δ s settled.

Level 1: GBBGGBBG
 Level 2: RGRBRGRB
 Level 3: RBRGRBRG
 Level 4: GBBRGGBR

4 settled Δ s
 44 S_2 : 0 settled

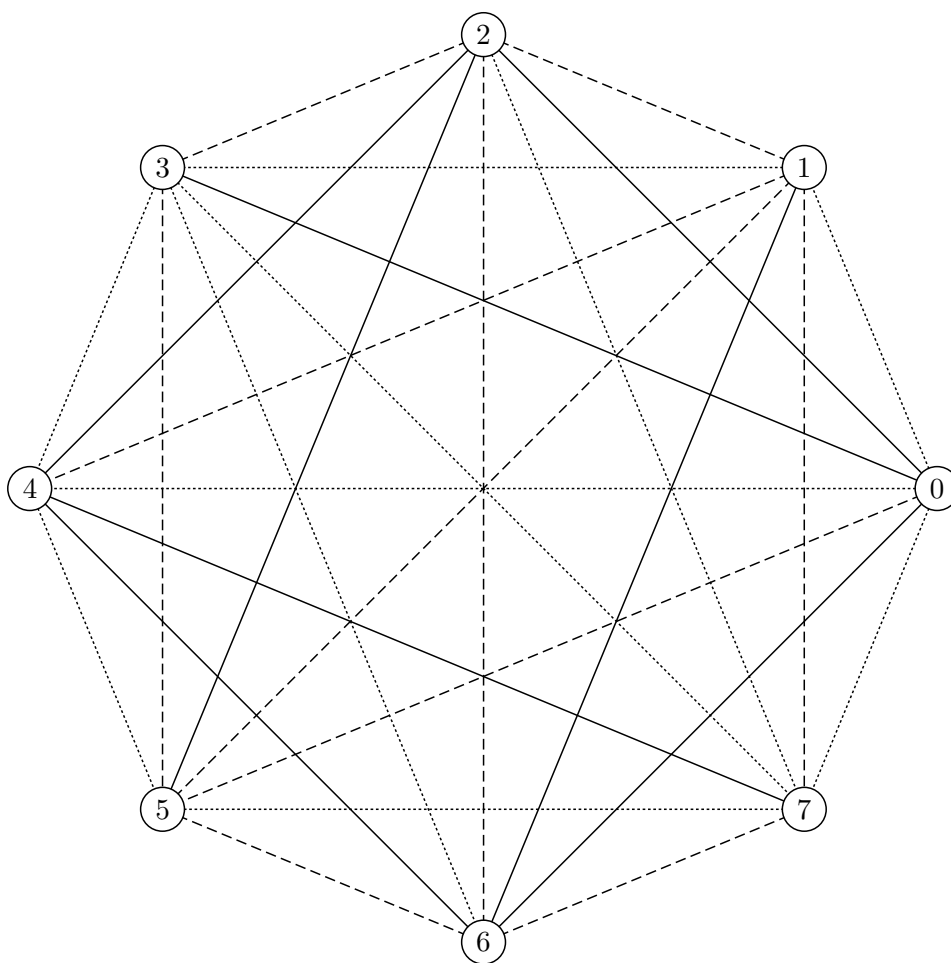

Figure 35: 4-cycle (in black and white for printing). This 3-graph was constructed by Andrey Gol'berg in 1984.

Now, let us consider four Δ s with one common vertex as shown in Figure 36. This construction we call a 4-*flower*. It can be extended to a 3-graph, as shown in Figure 38, in which all four Δ s are settled “counterclockwise” (i.e., Δ s induced by the triplets $\{0, 1, 2\}$, $\{0, 3, 4\}$, $\{0, 5, 6\}$, and $\{0, 7, 8\}$ are settled by the pairs $\{3, 4\}$, $\{5, 6\}$, $\{7, 8\}$, and $\{1, 2\}$, respectively). Although four more Δ s (induced by the triplets $\{0, 1, 6\}$, $\{0, 2, 5\}$, $\{0, 4, 7\}$, and $\{0, 3, 8\}$) appear in this extension), yet they are settled too. Moreover, 2-projections of this 3-graph contain twenty induced 2-combs that are all settled. However, there exist also eight induced 3-combs that are not settled.

Using a computer, we analyzed also some larger flowers (namely, $2j$ -flowers for $j = 3, 4, 5$, and 6) shown below. In all these examples all Δ s are settled. However, in agreement with Conjecture 4, for each of these 3-graphs always there is a 2-projection that contains an unsettled comb or anti-comb.

We have to explain the notation used in the figures. The three colors are red R , blue B , and green G , and we denote them by solid, dashed, and dotted lines, respectively.

In a $2j$ -flower we denote the central vertex by 0 and other vertices are labeled by $1, 2, \dots, 2j - 1, 2j$. Due to the symmetry, we can describe this 3-graph in terms of a list of colors L present in level i , where level i contain all edges (a, b) such that $a - b = \pm i \pmod{n}$. Clearly, we only need to provide the color lists from level 1 to j , since level i gives the same assignment as level $2j - i$. Finally Level 0 shows the coloring of the radial edges. For example, the 4-flower on Figure 38 is colored as follows:

Level 0:

the edges $(0, 1), (0, 2), (0, 3), (0, 4), (0, 5), (0, 6), (0, 7), (0, 8)$ are colored by $RGRGRGRG$.

Level 1:

the edges $(1, 2), (2, 3), (3, 4), (4, 5), (5, 6), (6, 7), (7, 8), (8, 1)$ are colored by $BGBGBGBG$;

Level 2:

the edges $(1, 3), (2, 4), (3, 5), (4, 6), (5, 7), (6, 8), (7, 1), (8, 2)$ are all colored by $BBBBBBBB$;

Level 3:

the edges $(1, 4), (2, 5), (3, 6), (4, 7), (5, 8), (6, 1), (7, 2), (8, 3)$ are colored by $RBRBRBRB$;

Level 4:

the edges $(1, 5), (2, 6), (3, 7), (4, 8), (5, 1), (6, 2), (7, 3), (8, 4)$ are colored by $RGRG(RGRG)$.

Level 0: RGRGRGRG
 Level 1: BGBGBGBG
 Level 2: BBBB BBBB
 Level 3: RBRBRBRB
 Level 4: RGRGRGRG

8 Δ s: 8 settled
 20 S_2 : 20 settled
 8 S_3 : 0 settled

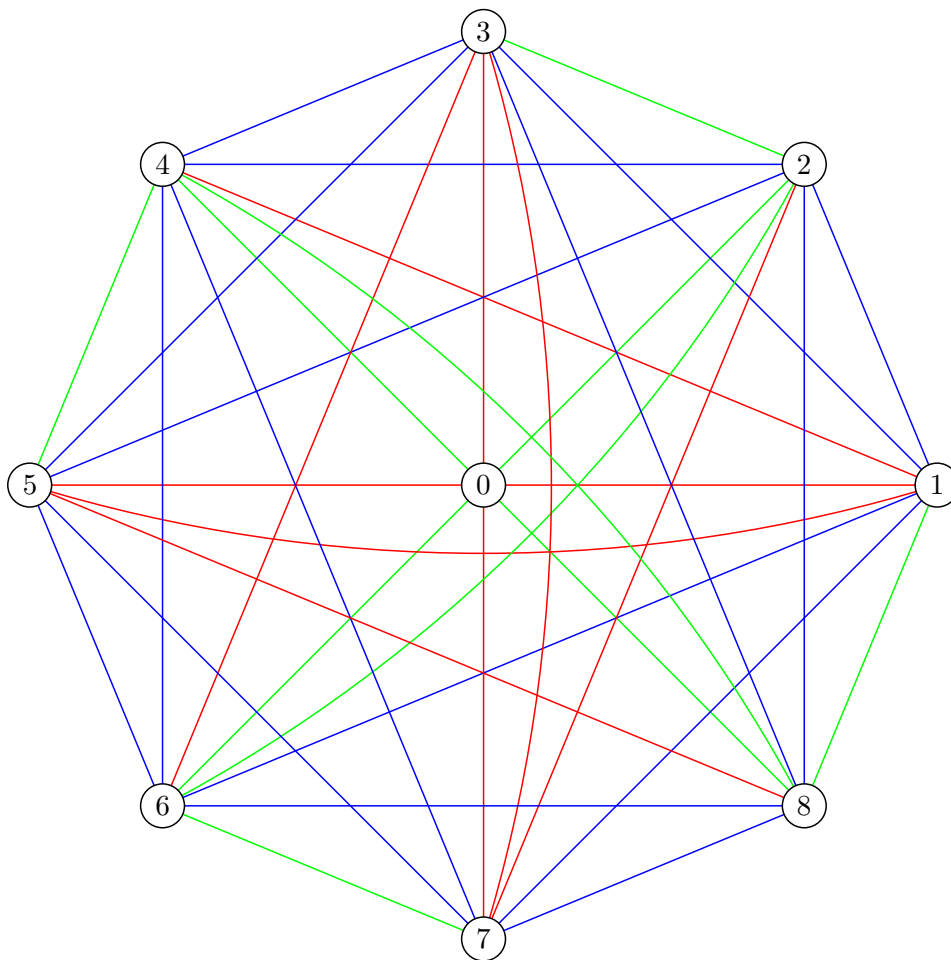

Figure 37: 4-flower example.

Level 0: RGRGRGRG
 Level 1: BGBGBGBG
 Level 2: BBBB BBBB
 Level 3: RBRBRBRB
 Level 4: RGRGRGRG

8 Δ s: 8 settled
 20 S_2 : 20 settled
 8 S_3 : 0 settled

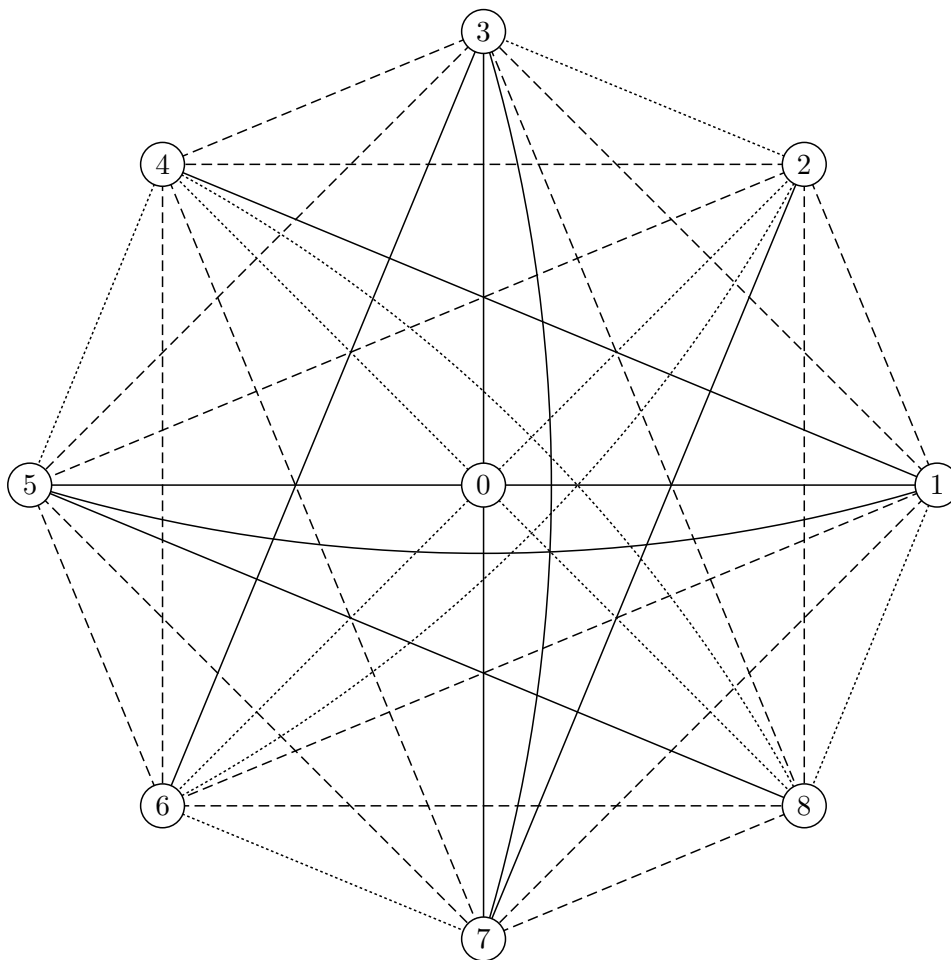

Figure 38: 4-flower example (in black and white for printing).

Level 0: RGRGRGRGRGRG
 Level 1: BGBGBGBGBGBG
 Level 2: BBBBBBBBBBBBBB
 Level 3: RBRBRBRBRBRB
 Level 4: RGRGRGRGRGRG
 Level 5: BRBRBRBRBRBR
 Level 6: BBBBBBBBBBBBBB

18 Δ s: 18 settled
 66 S_2 : 66 settled
 38 S_3 : 20 settled
 6 S_4 : 0 settled

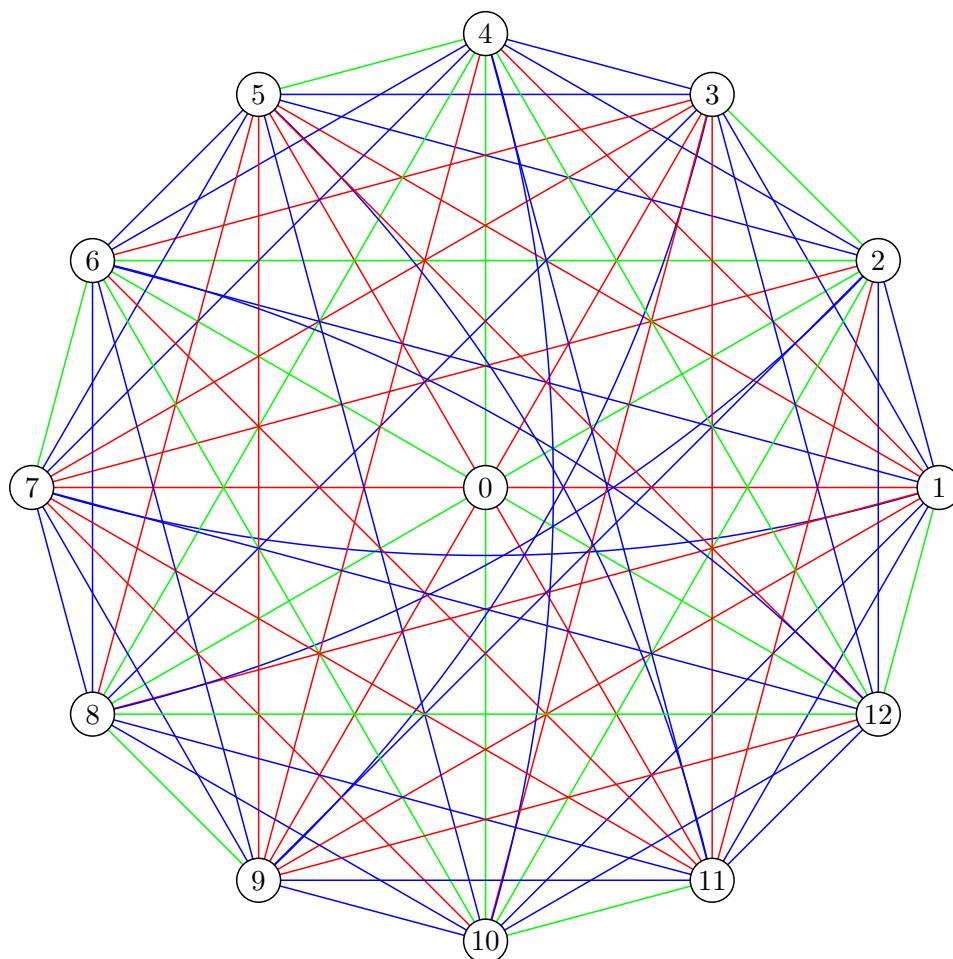

Figure 39: 6-flower example.

Level 0: RGRGRGRGRGRG
 Level 1: BGBGBGBGBGBG
 Level 2: BBBBBBBBBBBB
 Level 3: RBRBRBRBRBRB
 Level 4: RGRGRGRGRGRG
 Level 5: BRBRBRBRBRBR
 Level 6: BBBBBBBBBBBB

18 Δ s: 18 settled
 66 S_2 : 66 settled
 38 S_3 : 20 settled
 6 S_4 : 0 settled

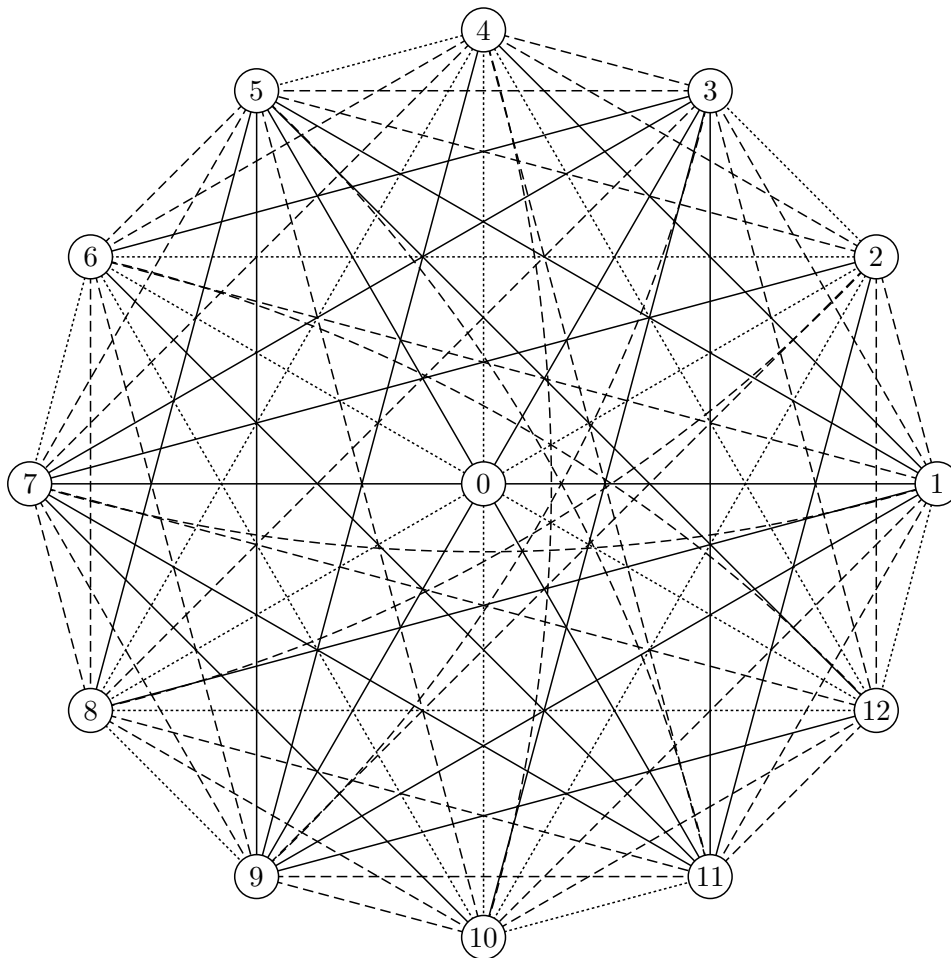

Figure 40: 6-flower example (in black and white for printing). This 3-graph was constructed by Bianca Viray in 2004.

Level 0: RGRGRGRGRGRGRGRG
 Level 1: BGBGBGBGBGBGBGBG
 Level 2: BBBBBBBBBBBBBBBBB
 Level 3: RBRBRBRBRBRBRBRB
 Level 4: RGRGRGRGRGRGRGRG
 Level 5: BRBRBRBRBRBRBRBR
 Level 6: BBBBBBBBBBBBBBBBB
 Level 7: BGBGBGBGBGBGBGBG
 Level 8: RRRRRRRRRRRRRRRR

32 Δ s: 32 settled
 192 S_2 : 192 settled
 256 S_3 : 0 settled

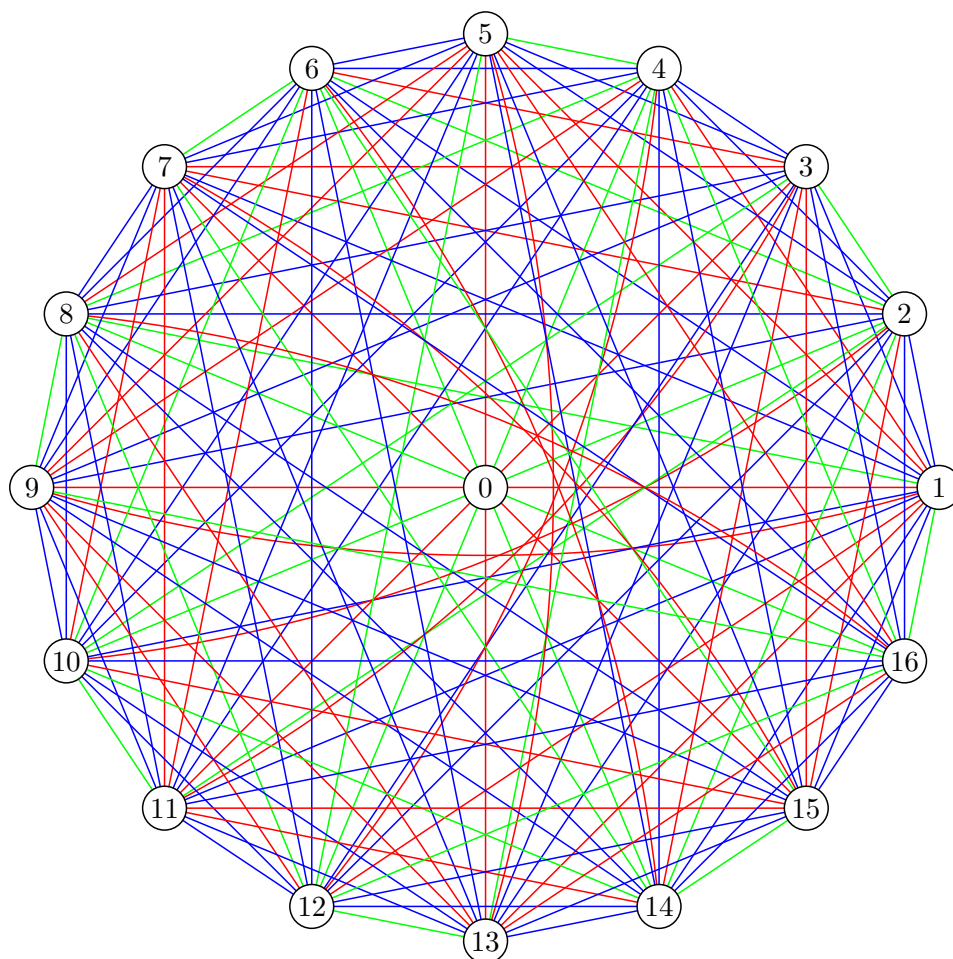

Figure 41: 8-flower example.

Level 0: RGRGRGRGRGRGRGRG
 Level 1: BGBGBGBGBGBGBGBG
 Level 2: BBBBBBBBBBBBBBBBB
 Level 3: RBRBRBRBRBRBRBRB
 Level 4: RGRGRGRGRGRGRGRG
 Level 5: BRBRBRBRBRBRBRBR
 Level 6: BBBBBBBBBBBBBBBBB
 Level 7: GBGBGBGBGBGBGBG
 Level 8: RRRRRRRRRRRRRRRR

32 Δ s: 32 settled
 192 S_2 : 192 settled
 256 S_3 : 0 settled

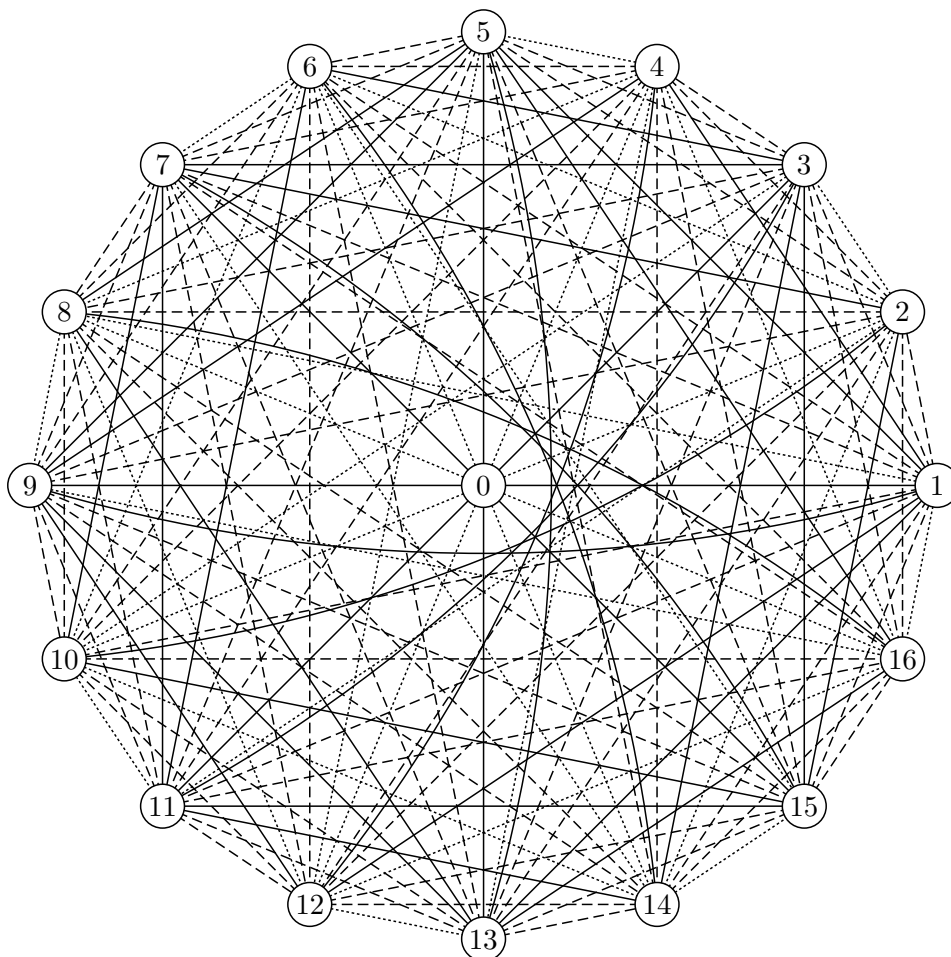

Figure 42: 8-flower example (in black and white for printing).

Level 0: RGRGRGRGRGRGRGRGRGRG
 Level 1: BGBGBGBGBGBGBGBGBGBG
 Level 2: BBBBBBBBBBBBBBBBBBBB
 Level 3: RBRBRBRBRBRBRBRBRBRB
 Level 4: RGRGRGRGRGRGRGRGRGRG
 Level 5: BRBRBRBRBRBRBRBRBRBR
 Level 6: BBBBBBBBBBBBBBBBBBBB
 Level 7: RBRBRBRBRBRBRBRBRBRB
 Level 8: RGRGRGRGRGRGRGRGRGRG
 Level 9: BRBRBRBRBRBRBRBRBRBR
 Level 10: BBBBBBBBBBBBBBBBBBBB

50 Δ s: 50 settled
 290 S_2 : 290 settled
 220 S_3 : 120 settled
 110 S_4 : 0 settled

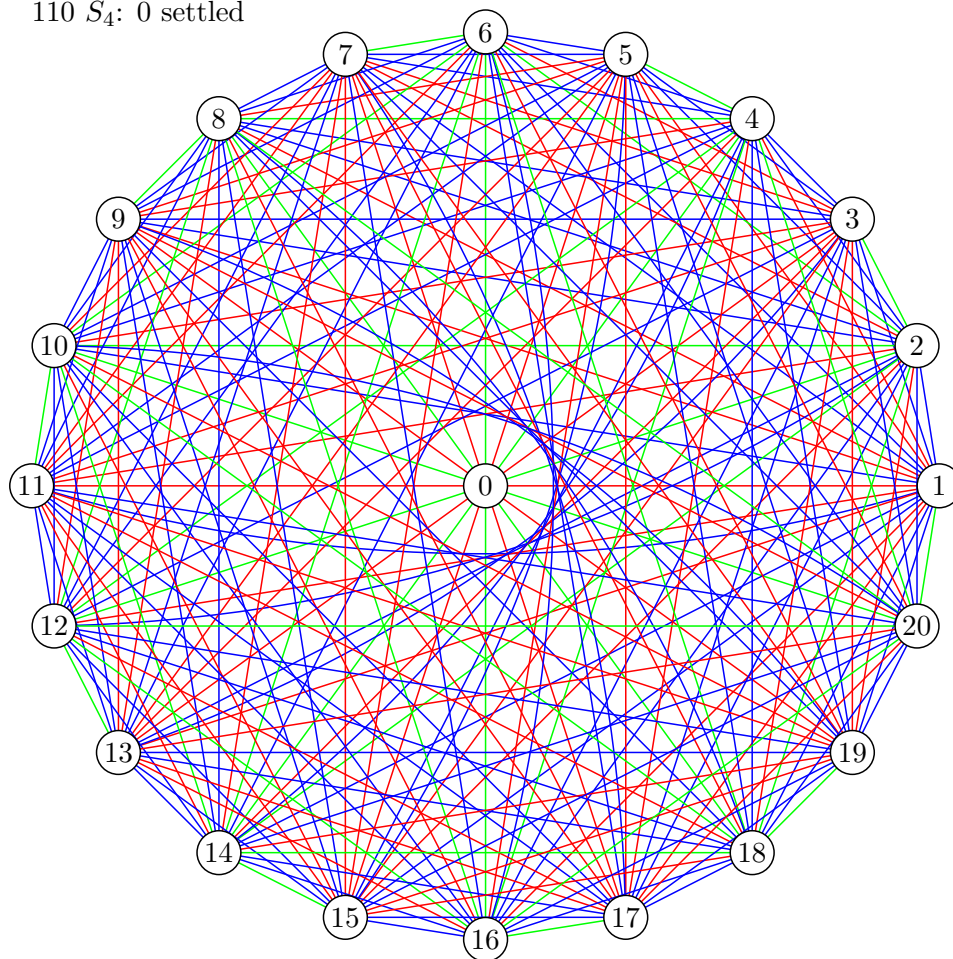

Figure 43: 10-flower example.

Level 0: RGRGRGRGRGRGRGRGRGRG
 Level 1: BGBGBGBGBGBGBGBGBGBG
 Level 2: BBBBBBBBBBBBBBBBBBBB
 Level 3: RBRBRBRBRBRBRBRBRBRB
 Level 4: RGRGRGRGRGRGRGRGRGRG
 Level 5: BRBRBRBRBRBRBRBRBRBR
 Level 6: BBBBBBBBBBBBBBBBBBBB
 Level 7: RBRBRBRBRBRBRBRBRBRB
 Level 8: RGRGRGRGRGRGRGRGRGRG
 Level 9: BRBRBRBRBRBRBRBRBRBR
 Level 10: BBBBBBBBBBBBBBBBBBBB

50 Δ s: 50 settled
 290 S_2 : 290 settled
 220 S_3 : 120 settled
 110 S_4 : 0 settled

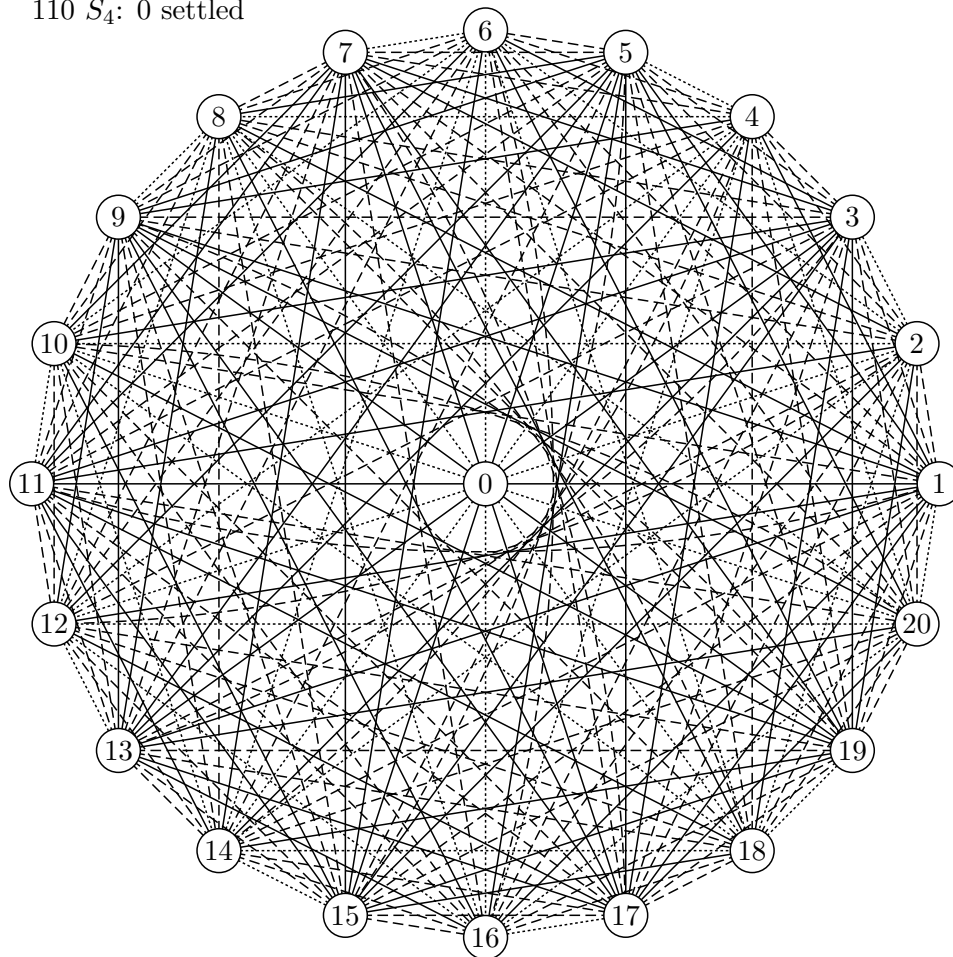

Figure 44: 10-flower example (in black and white for printing).

Level 0: RGRGRGRGRGRGRGRGRGRGRGRG
 Level 1: BGBGBGBGBGBGBGBGBGBGBGBG
 Level 2: BBBBBBBBBBBBBBBBBBBBBBBBBB
 Level 3: RBRBRBRBRBRBRBRBRBRBRBRB
 Level 4: RRRRRRRRRRRRRRRRRRRRRRRR
 Level 5: BRBRBRBRBRBRBRBRBRBRBRB
 Level 6: BBBBBBBBBBBBBBBBBBBBBBBBBB
 Level 7: RBRBRBRBRBRBRBRBRBRBRBRB
 Level 8: RGRGRGRGRGRGRGRGRGRGRGRG
 Level 9: BGBGBGBGBGBGBGBGBGBGBGBG
 Level 10: BBBBBBBBBBBBBBBBBBBBBBBBBB
 Level 11: RBRBRBRBRBRBRBRBRBRBRBRB
 Level 12: RRRRRRRRRRRRRRRRRRRRRRRR

72 settled Δ s
 600 S_2 : 600 settled
 184 S_3 : 76 settled
 24 S_4 : 0 settled

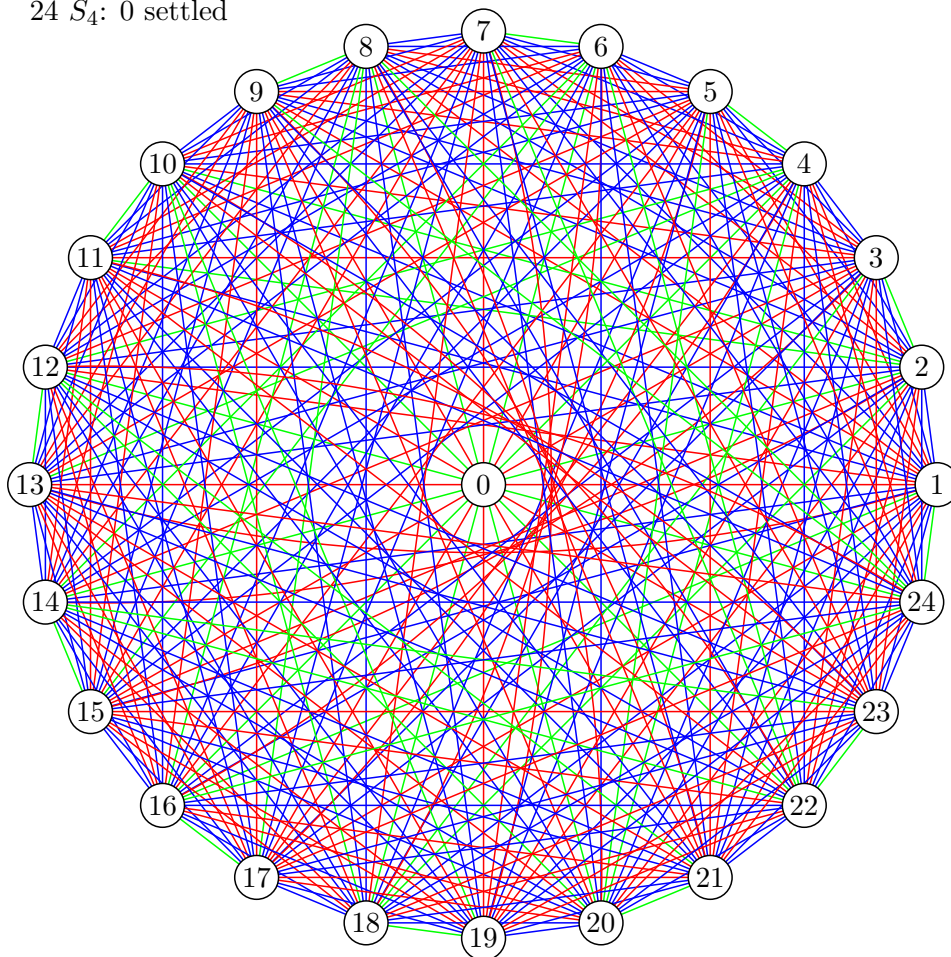

Figure 45: 12-flower example.

Level 0: RGRGRGRGRGRGRGRGRGRGRG
Level 1: BGBGBGBGBGBGBGBGBGBGBG
Level 2: BBBBBBBBBBBBBBBBBBBBBBBBB
Level 3: RBRBRBRBRBRBRBRBRBRBRBRB
Level 4: RRRRRRRRRRRRRRRRRRRRRRRR
Level 5: BRBRBRBRBRBRBRBRBRBRBRBR
Level 6: BBBBBBBBBBBBBBBBBBBBBBBBB
Level 7: RBRBRBRBRBRBRBRBRBRBRBRB
Level 8: RGRGRGRGRGRGRGRGRGRGRGRG
Level 9: BGBGBGBGBGBGBGBGBGBGBG
Level 10: BBBBBBBBBBBBBBBBBBBBBBBBB
Level 11: RBRBRBRBRBRBRBRBRBRBRBRB
Level 12: RRRRRRRRRRRRRRRRRRRRRRRR

72 settled Δ s
600 S_2 : 600 settled
184 S_3 : 76 settled
24 S_4 : 0 settled

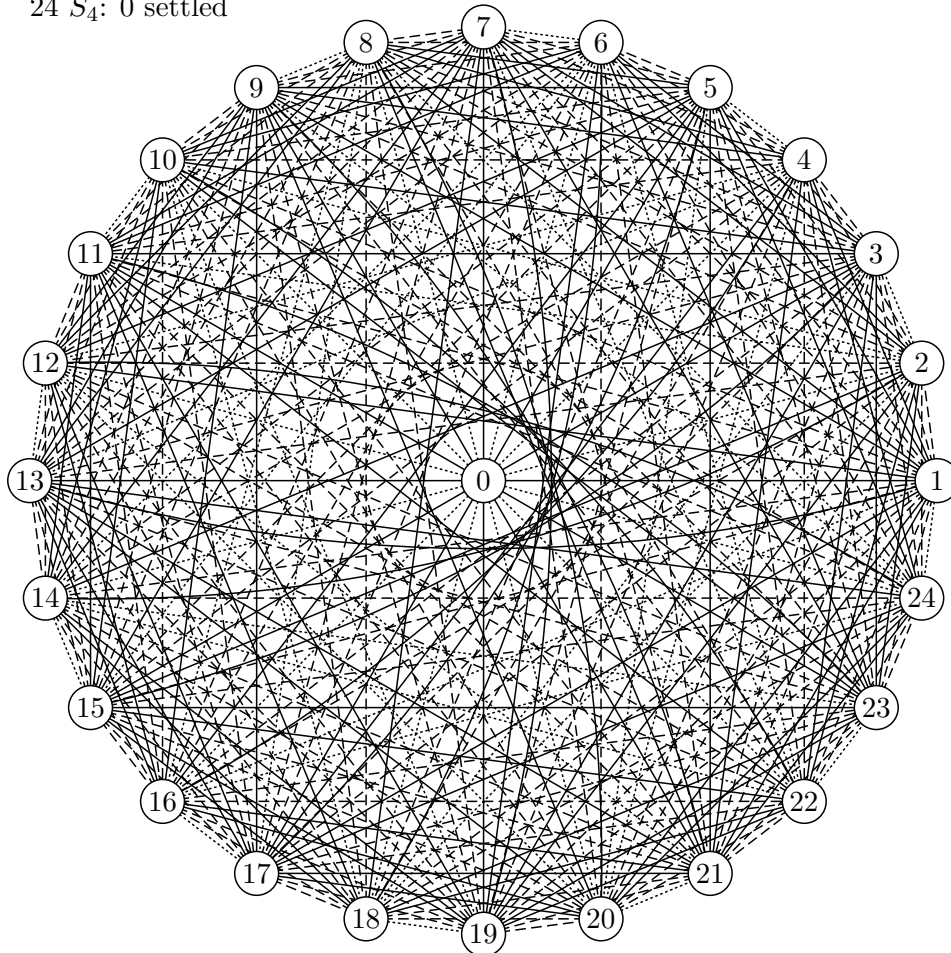

Figure 46: 12-flower example (in black and white for printing).

References

- [1] R.N. Ball, A. Pultr and P. Vojtěchovský, Colored graphs without colorful cycles, to appear in *Combinatorica*, <http://www.math.du.edu/data/preprints/m0506.pdf>
- [2] E. Boros and V. Gurvich, Perfect graphs are kernel-solvable, RUTCOR Research Report, RRR-16-1994, Rutgers University, *Discrete Math.* 159 (1996), 35-55.
- [3] E. Boros and V. Gurvich, Stable effectivity functions and perfect graphs, RUTCOR Research Report, RRR-23-1995, Rutgers University, *Mathematical Social Sciences* 39 (2000), 175-194.
- [4] E. Boros, V. Gurvich and A. Vasin, Stable families of coalitions and normal hypergraphs, RUTCOR Research Report, RRR-22-1995, Rutgers University, *Mathematical Social Sciences* 34 (1997), 107-123.
- [5] E. Boros, V. Gurvich and P.L. Hammer (1993), Dual subimplicants of positive Boolean functions, RUTCOR Research Report, RRR-11-1993, Rutgers University, *Optimization Methods and Software* 10, 1998, 147-156.
- [6] A Brandstädt, V.B. Le, and J.P. Spinrad, *Graph classes: a survey*, SIAM, Philadelphia, 1999.
- [7] H. Buer and R. Möring, A fast algorithm for decomposition of graphs and posets. *Math. Oper. Res.* 3 (1983), 170-184.
- [8] K. Cameron and J. Edmonds, Lambda composition, *J. Graph Theory* 26 (1997) 9-16.
- [9] K. Cameron, J. Edmonds, and L. Lovász, A note on perfect graphs, *Periodica Math. Hungar.* 17(3) (1986), 441-447.
- [10] F.R.K. Chung and R.L. Graham, Edge-colored complete graphs with precisely colored subgraphs, *Combinatorica* 3 (1983) 315-324.
- [11] A. Cournier and M. Habib, A new linear algorithm for modular decomposition, in *Proc. of 19th Internat. Coll. on Trees in Algebra and Programming (CAAP-94)*, Edinburgh, Scotland (S. Tison ed.), LNCS 787, Springer, Berlin (1994), 68-82.
- [12] T. Eiter, Exact transversal hypergraphs and application to Boolean μ -functions. *J. Symbolic Computation* 17 (1994) 215-225.
- [13] T. Eiter, Generating Boolean μ -expressions. *Acta Informatica*, 32 (1995) 171-187.
- [14] P. Erdős, M. Simonovits, and V.T. Sos, Anti-Ramsey theorems, *Coll. Math. Soc. J. Bolyai* 10 (1973), 633-643.

- [15] S. Foldes and P.L. Hammer, Split graphs; in Proc. of the 8th Southeastern Conference on Combinatorics, Graph Theory, and Computing (Louisiana State Univ., Baton Rouge, La, 1977) *Congressus Numerantium XIX* (1977), 311-315.
- [16] T. Gallai, Transitiv orientierbare graphen, *Acta Math. Acad. Sci. Hungar.*, 18 (1-2) (1967), 25-66. English translation by F. Maffray and M. Preissmann, in: *Perfect Graphs* (Chapter 3) eds. J.L.R Alfonsin and B.A. Reed, John Wiley and Sons.
- [17] M.C. Golumbic and V. Gurvich, Read-once functions, chapter in: *Boolean Functions* (Y. Crama and P.L. Hammer, eds.), to appear.
- [18] V.Gurvich, On repetition-free Boolean functions, *Uspechi mat. nauk* (Russian Math. Surveys), 32, no 1 (1977), 183-184 (in Russian).
- [19] V. Gurvich, Applications of Boolean functions and contact schemes in game theory, section 5, Repetition-free Boolean functions and normal forms of positional games (1978), Ph.D. thesis, Moscow Inst. of Physics and Technology, Moscow, USSR (in Russian).
- [20] V. Gurvich, On the normal form of positional games, *Soviet math. dokl.*, 25, no 3 (1982) 572-575.
- [21] V. Gurvich, Some properties and applications of complete edge-chromatic graphs and hypergraphs, *Soviet math. dokl.*, 30, no 3 (1984) 803-807.
- [22] V. Gurvich, Criteria for repetition-freeness of functions in the Algebra of Logic, *Russian Acad. of Sci. Dokl. Math.*, **43**, no 3 (1991) 721- 726.
- [23] V. Gurvich, 1992, Positional game forms and edge-chromatic graphs, *Russian Acad. of Sci. Dokl. Math.*, **45**, no 1 (1992) 168-172.
- [24] A. Gyárfás and G. Simonyi, Edge coloring of complete graphs without tricolored triangles, *J. Graph Theory* 46 (2004), 211-216.
- [25] M.Karchmer, N.Linial, L. Newman, M. Saks, A. Wigderson, Combinatorial characterization of read-once formulae, *Discrete Math.* **114** (1993) 275-282.
- [26] T. Kloks, C.-M. Lee, J. Liu, and H. Müller, On the recognition of general partition graphs, in: *Graph-theoretic concepts of computer science*, Lecture Notes in Comput. Sci. 2880 (Springer, Berlin, 2003) 273-283.
- [27] J. Körner and G. Simonyi, Graph pairs and their entropies: modularity problems, *Combinatorica* 20 (2000) 227-240.
- [28] J. Körner, G. Simonyi, and Zs. Tuza, Perfect couples of graphs, *Combinatorica* 12 (1992) 179-192.

- [29] L. Lovász, Normal hypergraphs and the weak perfect graph conjecture, *Discrete Math.*, 2 (3) (1972), 253-267.
- [30] L. Lovász A characterization of perfect graphs, *J. Combinatorial Theory, (Ser. B)* 13 (2) (1972), 95-98.
- [31] L. Lovász, *Combinatorial problems and Exercises*, North-Holland Publishing Co., Amsterdam, New York, Oxford, 1979.
- [32] McAvaney, J. Robertson, and D. DeTemple, A characterization and hereditary properties for partition graphs, *Discrete Math.* 113 (1-3) (1993) 131-142.
- [33] R.M. McCollel and J.P. Spinrad, Modular decomposition and transitive orientation, *Discrete Math.* 201 (1999), 189-241.
- [34] R. Möring, Algorithmic aspects of the substitution decomposition in optimization over relations, set systems, and Boolean functions, *Ann. Oper. Res.* 4 (1985/6), 195-225.
- [35] J. Muller and J. Spinrad, Incremental modular decomposition, *J. ACM* **36** (1) (1989), 1-19.
- [36] Yu.L. Orlovich and I.E. Zverovich, Independent domination and the triangle condition, 12 pp. To appear.
- [37] G. Ravindra, Strongly perfect line graphs and total graphs, in *Finite and infinite sets*, 6-th Hungarian Combinatorial Colloquium, vol. 2, Eger, Hungary, 1981, *Colloq. Math. Soc. Janos Bolyai* 37 (1984) 621-633.
- [38] I.Zverovich and I.Zverovich, Bipartite hypergraphs: A survey and new results, *Discrete Math.* 306 (2006) 801-811